

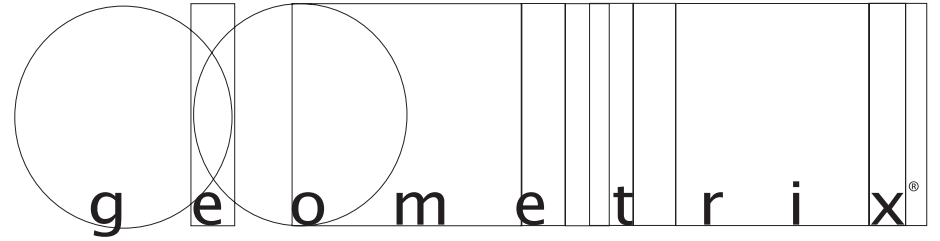

Schonbek Worldwide Lighting Inc., 61 Industrial Blvd., Plattsburgh NY 12901-1908  
Tel: 800.836.1892 or 518.563.7500 [www.schonbek.com](http://www.schonbek.com) or [www.geometrix-lighting.com](http://www.geometrix-lighting.com)  
For cleaning instructions, visit [www.schonbek.com](http://www.schonbek.com) or [www.geometrix-lighting.com](http://www.geometrix-lighting.com)

© 2008 SCHONBEK WORLDWIDE LIGHTING INC., A. SCHONBEK & CO. LTD. WORLDWIDE COPYRIGHT RESERVED  
US UTILITY PATENT PENDING



Trim Diagram  
Pendant DI1807\*\*

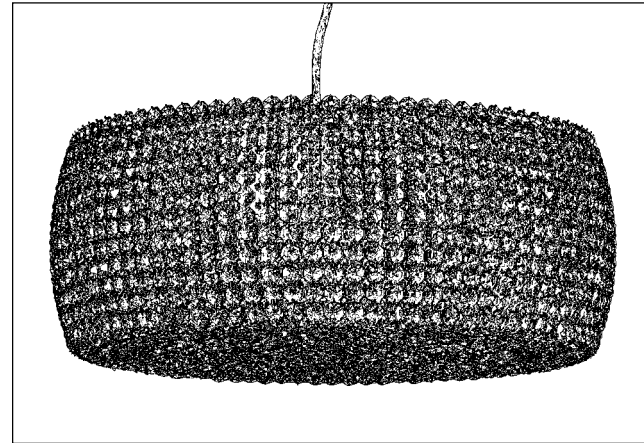

3 Lights  
Diameter: 18"  
Height: 7"

Geometrix™ is designed by Schonbek with Strass® crystal by Swarovski.



This design is the proprietary trade dress/trademark of Schonbek Worldwide Lighting Inc

Please save your trim diagram for future reference.

**IMPORTANT:** Label on back contains important information on your crystal color. Please save in case you ever need to order matching crystal.



## Instructions for electrician STEP 1

All electrical components must be installed by a licensed electrician in accordance with the National Electric Code and the appropriate local electrical codes.

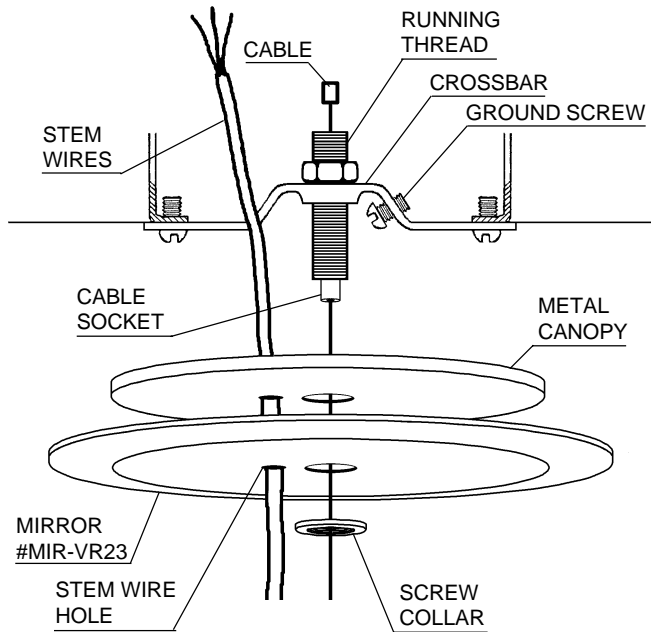

**1** Remove the screw collar, mirror, metal canopy from the canopy assembly and attach crossbar using hardware (not provided) to outlet box. Feed suspension cable through running thread from the top so that the cast cable end is seated in the inside of the cable socket. Attach crossbar to the ceiling with cable hanging down. Feed suspension cable through the center hole (larger hole) of the canopy, mirror and then screw collar. The metal canopy must be finish side down and on top of the mirror with beveled side down. Feed cable into cable glider on chandelier frame and hang to desired height. Slide cable into glider and allow it to play out of the side of the cable glider. To adjust height, depress the cable gripper until the cable is released to move the frame up and down the cable. Feed stem wire through stem wire hole in mirror and metal canopy (the smaller hole). When pendant is at desired height, trim stem wire. **Caution** - Before wiring fixture, power must be turned off. Connect ground wire (green tracer) to crossbar and house (bare or green) ground wire. Next connect the neutral wire (white tracer) to the white house wire. Finally connect the power wire to the black house wire. Raise metal canopy and mirror to ceiling and secure to running thread with the screw collar. Supplied are 40 cable grips. Clip to support cable and adjust along stem wire every 3". Cut suspension cable with cable cutters leaving about 1/2" protruding from the side of the cable glider.

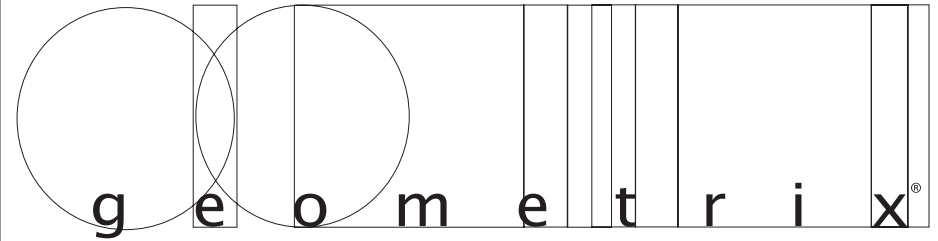

## Frequency of cleaning crystal

We know people who clean their crystal every few months, because they love handling the crystals and admiring them close up. Others do a cleaning every six or nine months.

To stretch the time between cleanings, dust lightly every two or three months with a feather duster, lambswool duster or make-up brush.

Frequency of cleaning depends on location of your Dionyx and other environmental factors.

Crystal needs cleaning when it appears dusty or dull. Just look at your Dionyx frequently (always enjoyable), and you'll know when it's time for a cleaning.

## REPLACING CRYSTAL OCTAGON:

If a crystal octagon breaks, you'll see a bare spot in the framework.

**A** Turn both tabs 90° counterclockwise on either side of pocket where the octagon should be.

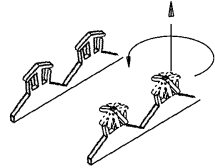

**B** Slide crystal octagon into pocket. Turn both tabs clockwise back to original position to hold the octagon in place.

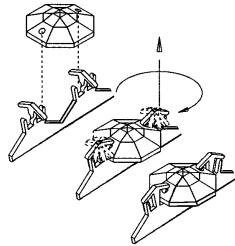

## REPLACING CRYSTAL BEAD:

If a crystal bead breaks, you'll see a bare spot in the framework.

**A** Use needle nose pliers and pull the empty "L" bracket straight out.



**B** Slide crystal bead onto the bracket. Use your thumb and push the bead and bracket back into place.

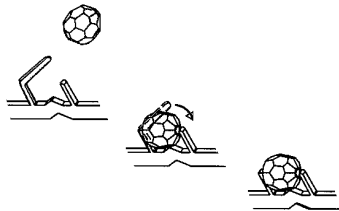

## NOTES:

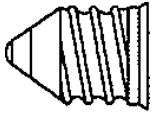

3 - A19, BT15, or JDD Bulbs  
(Halogen Bulbs Recommended)  
100 Watts Max  
Hanging Weight: 17 lbs.

Install bulbs and be sure to test  
fixture BEFORE assembly.

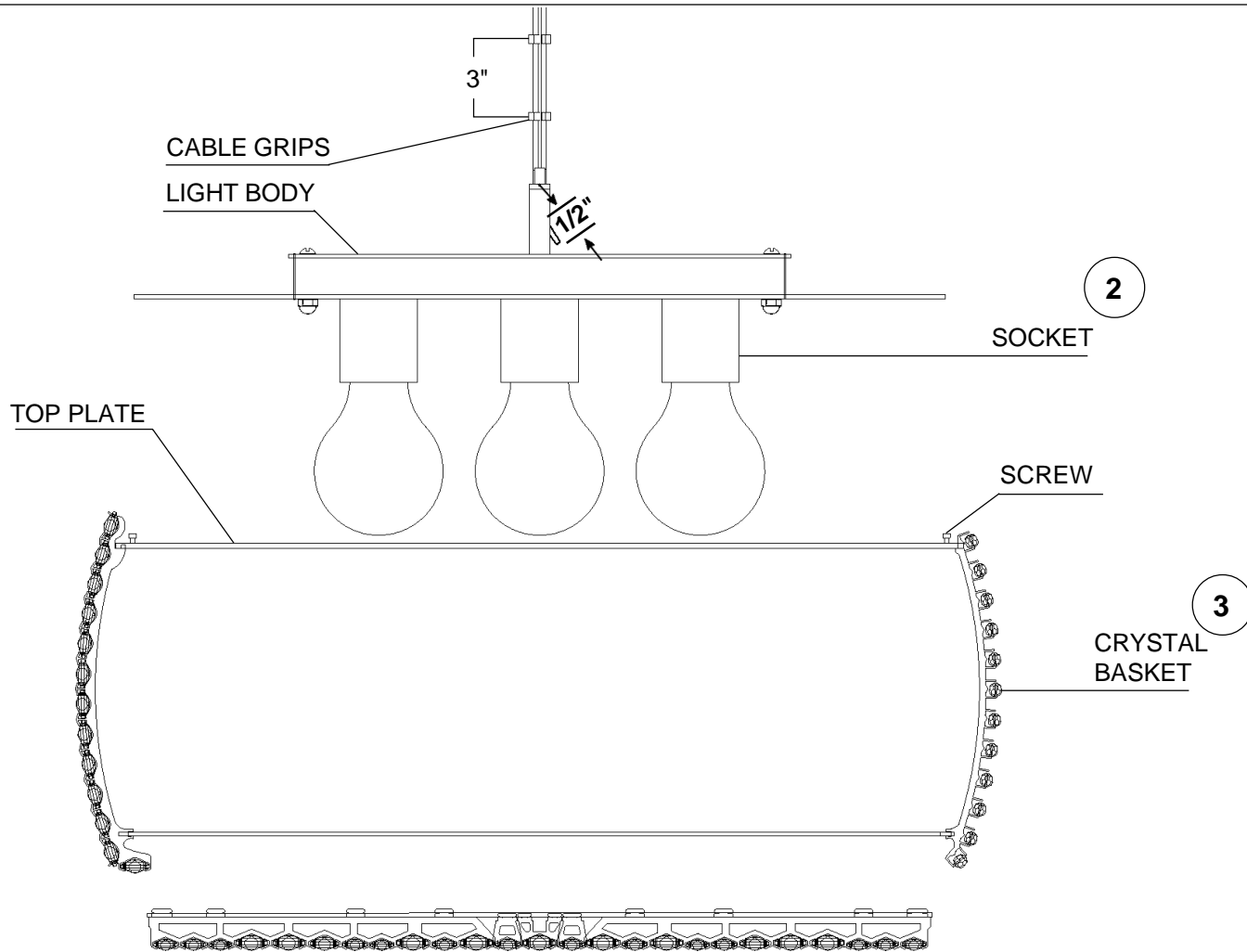

## How to Assemble Your Dionyx Pendant:

**2** Screw bulbs carefully but completely into sockets.

**3** Loosen the screws on the top plate with Phillips screw driver (not provided). Position the top plate of the pendant against the light body and secure in place by turning the crystal basket until the screws are seated in the light body. Tighten the screws down on the light body.