



 TREND

PORTABLE LIGHTING COLLECTION 2011



TT4080
TF7576
TP8755



BF5533
BA6000
BA6002
BA6003
TT9204
TFA9307



TP6417

TF3977-W
TFA7768-S
TT7900-W
TT7950

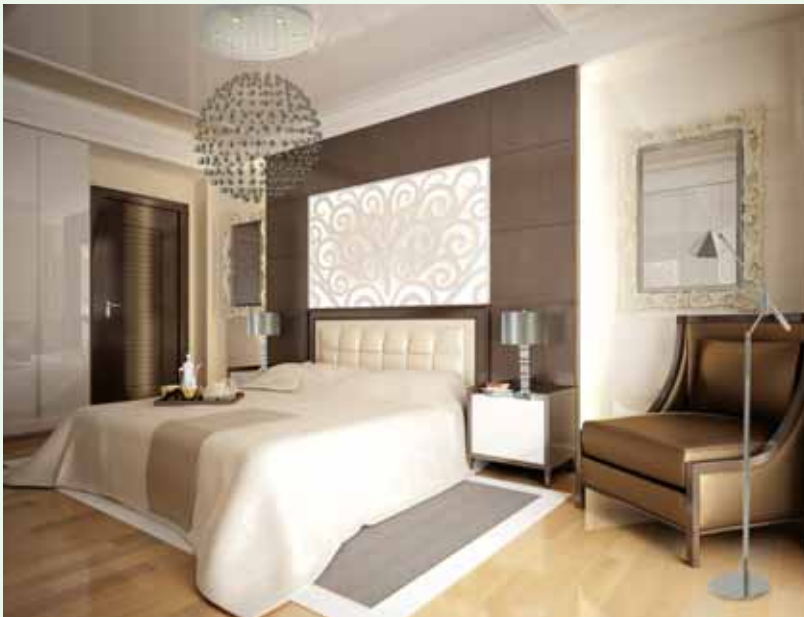

TT8723
TF2333
TP9506



TT1270
TP7588
BW8947



A



B

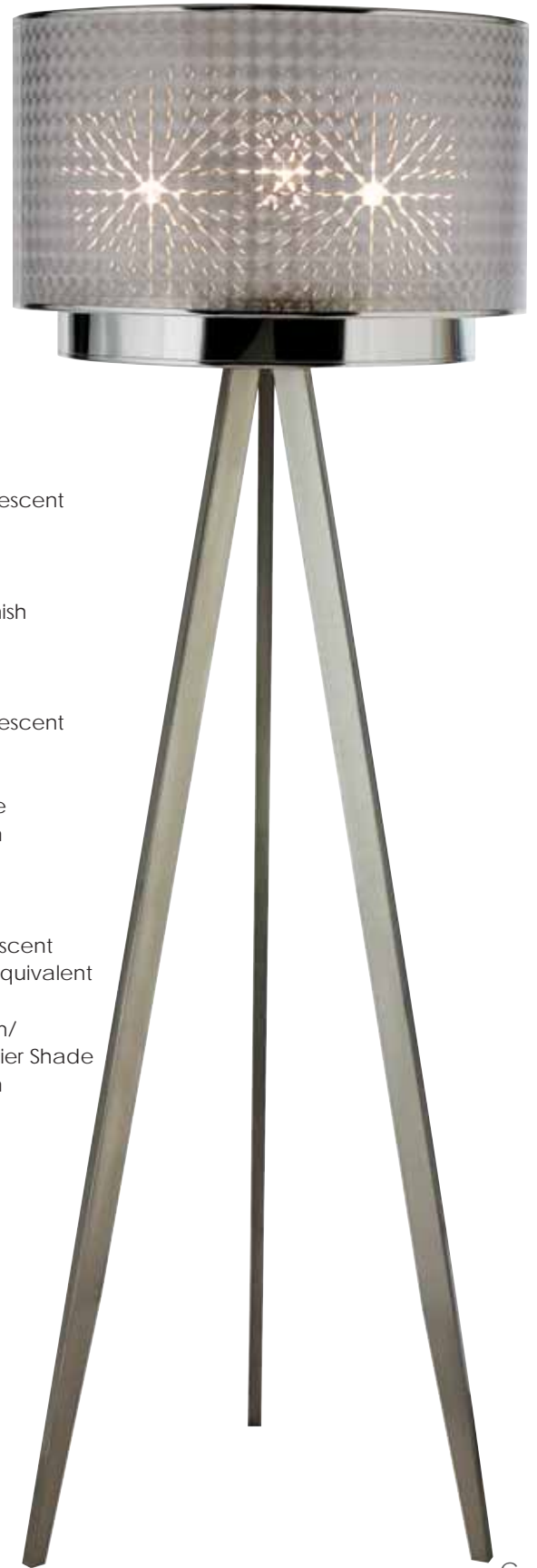

C

A. TT3120
28" Echo Lamp
1 x 150 Watt Incandescent
or CFL Equivalent
18" Oval Off-White
Vellum Shade
Polished Chrome Finish

B. TT3121
28" Echo Lamp
1 x 150 Watt Incandescent
or CFL Equivalent
18" Oval Off-White
Coarse Ivory Shade
Brushed Nickel Finish

C. TF7766-S
69" Paparazzi Lamp
3 x 60 Watt Incandescent
or Dimmable CFL Equivalent
Floor Dimmer
22" Checkered Prism/
Shaded Mirror Two Tier Shade
Brushed Nickel Finish



A. TF7766-B
 69" Paparazzi Lamp
 3 x 60 Watt Incandescent
 or Dimmable CFL Equivalent
 Floor Dimmer
 22" Smoke Shade/
 Shaded Mirror Two Tier Shade
 Brushed Nickel Finish

B. TT3100
 26.5" Infinity Lamp
 1 x 150 Watt Incandescent
 or CFL Equivalent
 18" Oval Off-White
 Vellum Shade
 Polished Chrome Finish

C. TT3101
 26.5" Infinity Lamp
 1 x 150 Watt Incandescent
 or CFL Equivalent
 18" Oval Off-White
 Coarse Ivory Shade
 Brushed Nickel Finish



B



C



A



A. TT7574

37" Linque Lamp
1 x 150 Watt Incandescent
or CFL Equivalent
17" Lattice Cream Linen Shade
Brushed Nickel Finish

B. TT3131

20" Escape Lamp
1 x 100 Watt Incandescent
or CFL Equivalent
Line Switch
16" Latte Linen Shade
Brushed Nickel Finish

C. TF7578

64" Linque Lamp
1 x 150 Watt Incandescent
or CFL Equivalent
20" Lattice Cream Linen Shade
Brushed Nickel Finish



B

C



A. TF7575

64" Linque Lamp
1 x 150 Watt Incandescent
or CFL Equivalent
20" Bronze Smoke Shade
Brushed Nickel Finish

B. TT7570

37" Linque Lamp
1 x 150 Watt Incandescent
or CFL Equivalent
18" Bronze Smoke Shade
Brushed Nickel Finish

C. TT3132

31.5" Escape Lamp
1 x 150 Watt Incandescent
or CFL Equivalent
18" Latte Linen Shade
Brushed Nickel Finish



A



B



C

A. TF7305

63.5" Precision Lamp
1 x 150 Watt Incandescent
or CFL Equivalent
20" Ivory Shantung Shade
Brushed Nickel Finish

B. TT7300

36.5" Precision Lamp
1 x 150 Watt Incandescent
or CFL Equivalent
19" Ivory Shantung Shade
Brushed Nickel Finish

C. TT9204

Alpine Lamp
32" H x 21" W
1 x 100 Watt Incandescent
Line Switch
13.5" Sheer Snow/Shantung Shade
Black Marble Base
Brushed Nickel Finish



A



C



B

A. TT7600

30.5" Dawn Lamp
 1 x 150 Watt Incandescent
 or CFL Equivalent
 18" Oval Latte Linen Shade
 Brushed Nickel Finish

B. TT7610

26.5" Dusk Lamp
 1 x 150 Watt Incandescent
 or CFL Equivalent
 18" Latte Linen Shade
 Brushed Nickel Finish

C. TT3130

27.5" Geometry Lamp
 1 x 150 Watt Incandescent
 or CFL Equivalent
 18" Oval Off-White
 Vellum Shade
 Polished Chrome Finish



A



B

A. TT4200-26
 29" Gustavian Lamp
 1 x 150 Watt Incandescent
 or CFL Equivalent
 15" Homespun Linen Shade
 Polished Chrome Finish

B. TT4060
 30" Wave II Lamp
 1 x 150 Watt Incandescent
 or CFL Equivalent
 17" Ivory Cross Woven Linen Shade
 Polished Chrome Finish

C. TT5650
 28" Reflections Lamp
 1 x 150 Watt Incandescent
 or CFL Equivalent
 15" Off-White Linen Shade
 Mirror/Polished Chrome Finish

D. TT7930
 Park Avenue Lamp
 19" H x 10.5" W
 1 x 60 Watt Incandescent
 Line Switch
 Seeded Shaker Glass
 Brushed Nickel Finish



C



D



A. TF8214

64" Station Lamp
 1 x 150 Watt Incandescent
 or CFL Equivalent
 17" Coarse Ivory Linen Shade
 White Marble Base
 Brushed Nickel Finish

B. TFA9307

Lux Tree Lamp
 83" H x 86" W
 69" Shade Clearance
 3 x 60 Watt Incandescent
 or CFL Equivalent
 4-Way Switch
 Sheer Snow/
 Shantung Two Tier Shade
 Black Marble Base
 Brushed Nickel Finish



B



A



B



C

A. TT7980

26" Apollo Glass Lamp
3 x 60 Watt Incandescent
or CFL Equivalent
Line Switch
14" Pearl Glass Shade
Polished Chrome Finish

B. TF7985

60.5" Apollo Glass Lamp
3 x 60 Watt Incandescent
Foot Switch
18" Pearl Glass Shade
Polished Chrome Finish

C. TF7992

61.5" Butler Lamp
2 x 60 Watt Incandescent
Foot Switch
19.75" Coarse Cream Linen Shade
Polished Chrome Finish



A

A. TT7991

28" Butler Lamp
2 x 60 Watt Incandescent
Line Switch
15.5" Coarse Cream Linen Shade
Polished Chrome Finish

B. TT7990

Butler Lamp
28" H x 15" W
1 x 100 Watt Incandescent
or CFL Equivalent
Line Switch
12" Coarse Cream Linen Shade
Polished Chrome Finish



B

C. TF7993

Butler Lamp
63" H x 18" W
1 x 100 Watt Incandescent
or CFL Equivalent
Foot Switch
15.5" Coarse Cream Linen Shade
Polished Chrome Finish



C



A



B



C



D

A. **BT1200**
 Basics By Trend
 21" Soleil Accent Lamp
 1 x 60 Watt Incandescent
 or CFL Equivalent
 8" Off-White Shantung Shade
 Sherbert Glass
 Ebony Lacquer

B. **BT1201**
 Basics By Trend
 21" Mystic Accent Lamp
 1 x 60 Watt Incandescent
 or CFL Equivalent
 8" Off-White Shantung Shade
 Sahara Glass
 Ebony Lacquer

C. **BT7162**
 Basics By Trend
 30" Roosevelt Lamp
 1 x 100 Watt Incandescent
 or CFL Equivalent
 15.5" Sheer Snow/
 Shantung Two Tier Shade
 Espresso/Brushed Nickel Finish

D. **BF7164**
 Basics By Trend
 61" Roosevelt Lamp
 1 x 100 Watt Incandescent
 or CFL Equivalent
 15.5" Sheer Snow/
 Shantung Two Tier Shade
 Espresso/Brushed Nickel Finish



A. BW7155

Basics By Trend
 Brella Swivel Arc Wall Lamp
 21" H x 24" W
 1 x 75 Watt Incandescent
 or CFL Equivalent
 12" Sheer Snow/
 Shantung Two Tier Shade
 24" Cord Cover Included with Plug
 Brushed Nickel Finish



B. BF5533

Basics By Trend
 61" Brella Lamp
 1 x 150 Watt Incandescent
 or CFL Equivalent
 18" Sheer Snow/
 Shantung Two Tier Shade
 Brushed Nickel Finish

C. BT7143

Basics By Trend
 30" Nimbus Lamp
 1 x 100 Watt Incandescent
 or CFL Equivalent
 13.5" Sheer Snow/Shantung Shade
 Metallic Silver/
 Polished Chrome Finish



D. BF7145

Basics By Trend
 61" Nimbus Lamp
 1 x 100 Watt Incandescent
 or CFL Equivalent
 13.5" Sheer Snow/
 Shantung Shade
 Metallic Silver/
 Polished Chrome Finish



B

C

D



A

A. BT7173-SB

Basics By Trend
 25" Pluto Lamp
 1 x 75 Watt Incandescent
 or CFL Equivalent
 12" Smooth Aluminum Shade
 Metallic Silver/Glossy Black Finish

B. BT7100-S

Basics By Trend
 25.5" Pure Lamp
 1 x 75 Watt Incandescent
 or CFL Equivalent
 12" Smooth Aluminum Shade
 Metallic Silver Finish



B



C

C. BT7102-S

Basics By Trend
 29.5" Pure Lamp
 1 x 100 Watt Incandescent
 or CFL Equivalent
 15.5" Smooth Aluminum Shade
 Metallic Silver Finish

D. BF7103-S

Basics By Trend
 61" Pure Lamp
 1 x 100 Watt Incandescent
 or CFL Equivalent
 15.5" Smooth Aluminum Shade
 Metallic Silver Finish



D

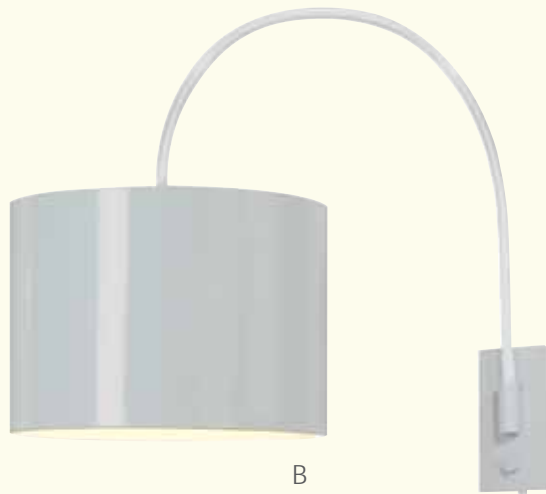

B



A



D



C



E

A. **BW7105-S** · Metallic Silver
 B. **BW7105-W** · Pure White
 Basics By Trend
 Pure Arc Wall Lamp
 21" H x 24" W
 1 x 75 Watt Incandescent
 or CFL Equivalent
 12" Smooth Aluminum Shade
 24" Cord Cover Included with Plug

C. **BT7102-W**
 Basics By Trend
 29.5" Pure Lamp
 1 x 100 Watt Incandescent
 or CFL Equivalent
 15.5" Smooth Aluminum Shade
 Pure White Finish

D. **T7100-W**
 Basics By Trend
 25.5" Pure Lamp
 1 x 75 Watt Incandescent
 or CFL Equivalent
 12" Smooth Aluminum Shade
 Pure White Finish

E. **BF7103-W**
 Basics By Trend
 61" Pure Lamp
 1 x 100 Watt Incandescent
 or CFL Equivalent
 15.5" Smooth Aluminum Shade
 Pure White Finish

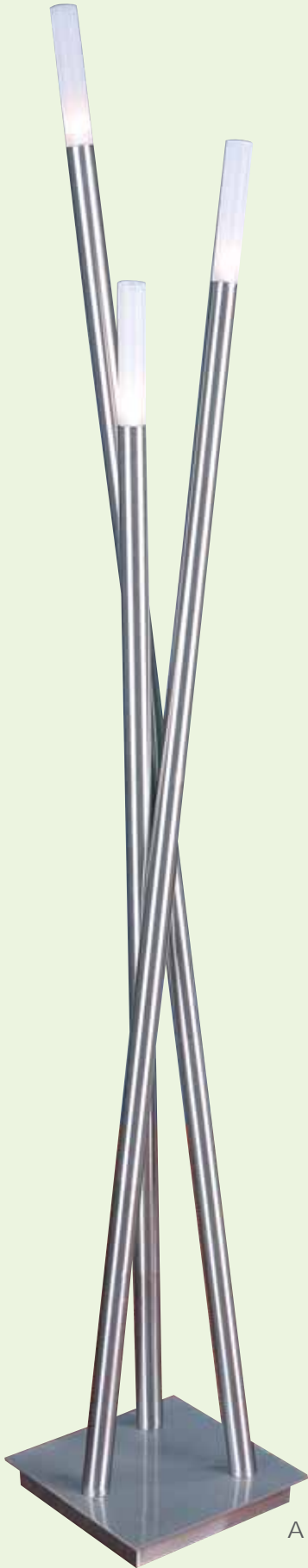

A



C



B



D

A. TF399

Cavelleto Lamp
66" H x 11" W
3 x 10 Watt Halogen Bulb Incl.
Satin Opal Glass
Brushed Nickel Finish

B. TTB420-26

Urban Basic Lamp
Adjusts 25 – 31"
2 x 60 Watt Pull Chain
or CFL Equivalent
16" Off-White Linen Shade
Polished Chrome Finish

C. TA390

Cavelleto Lamp
26" H x 8" W
3 x 10 Watt Halogen Bulb Incl.
Satin Opal Glass
Brushed Nickel Finish

D. TFB435-26

Urban Basic Lamp
Adjusts 53 – 59"
2 x 100 Watt Pull Chain
or CFL Equivalent
16" Off-White Linen Shade
Polished Chrome Finish



A. BT7151

Basics By Trend
 30" Cirrus Lamp
 1 x 100 Watt Incandescent
 or CFL Equivalent
 16" Ivory Kinwashi Shade
 Metallic Silver/Polished Chrome Finish

B. BF7153

Basics By Trend
 61" Cirrus Lamp
 1 x 100 Watt Incandescent
 or CFL Equivalent
 16" Ivory Kinwashi Shade
 Metallic Silver/Polished Chrome Finish

C. BFA8400

Brella Arc Lamp
 Adjust 69" – 74" H x 50" Max Ext
 Shade Clearance: 52" – 55"
 1 x 150 Watt Incandescent
 or Dimmable CFL Equivalent
 Floor Dimmer
 15" Sheer Snow/Shantung Shade
 White Marble Base
 Brushed Nickel Finish



A

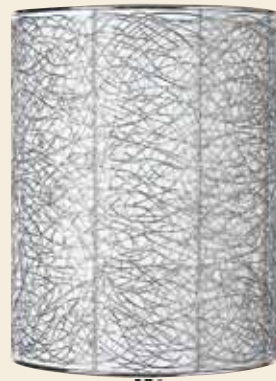

Shown With
Optional Diffuser



B



Shown Without
Optional Diffuser



C

A. TT1308
29" Sherbert Glass Lamp
1 x 150 Watt Incandescent
or CFL Equivalent
11" Off-White Shantung Shade
Brushed Nickel Finish

B. TT4820
22" Distratto Lamp
1 x 75 Watt Incandescent
or CFL Equivalent
7" Enmeshed Wire Shade
Includes Removable Diffuser
Polished Chrome Finish

C. TF4825
64" Distratto Lamp
1 x 100 Watt Incandescent
or CFL Equivalent
10" Enmeshed Wire Shade
Includes Removable Diffuser
Polished Chrome Finish

D. BA6000 · 9" Dia
E. BA6002 · 12" Dia
F. BA6003 · 15" Dia
Luminary Lamp
1 x 60 Watt Incandescent
or CFL Equivalent
Line Switch
Hand Woven Aluminum Wire
Silver Finish



D



E

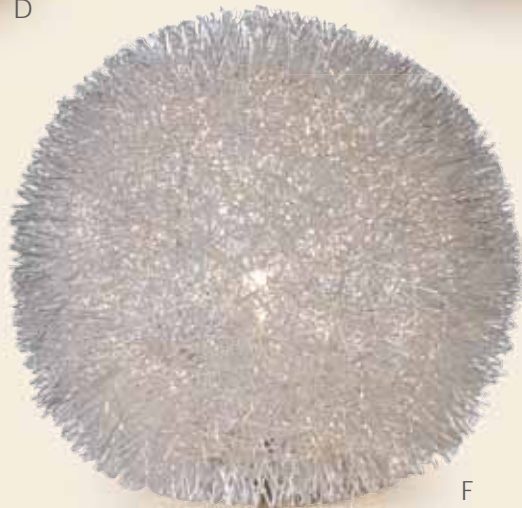

F

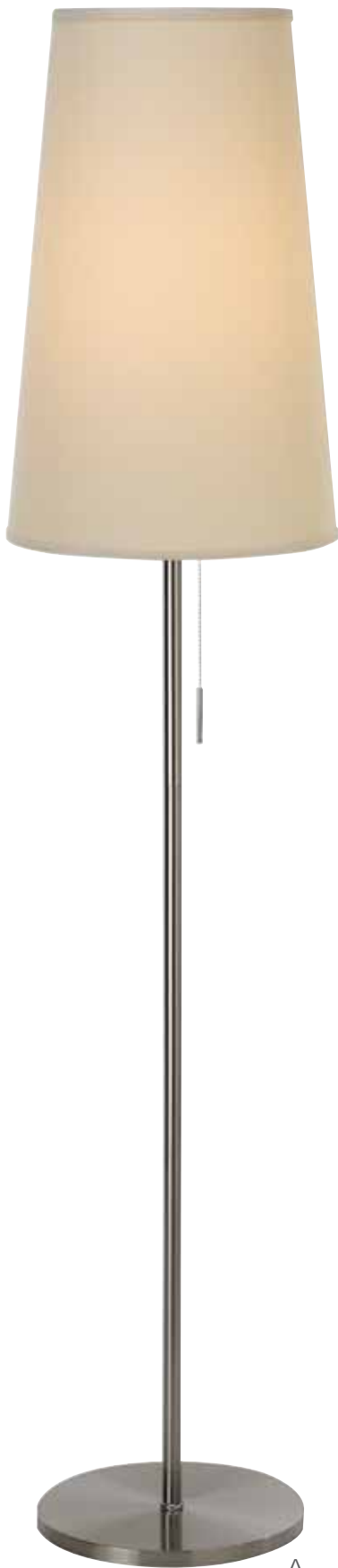

A

A. BF1674

61" Primo Lamp
1 x 100 Watt Incandescent
or CFL Equivalent
Pull Chain
13" Lattice Cream Linen
Brushed Nickel Finish



B

B. BT1672

26.5" Primo Lamp
1 x 75 Watt Incandescent
or CFL Equivalent
Pull Chain
9.5" Lattice Cream Linen
Brushed Nickel Finish



C

C. TT3092

17" Shift Lamp
1 x 150 Watt Incandescent
or CFL Equivalent
15" Platinum Sheen
Leaf-Shaped Shade
Brushed Nickel Finish

D. TF3094

58" Shift Lamp
1 x 150 Watt Incandescent
or CFL Equivalent
17" Platinum Sheen
Leaf-Shaped Shade
Brushed Nickel Finish

D





A. **TF2205** Puck Shade
 D. **TF2216** Tent Shade
 Slim LED Task Lamp
 Adj H: 35" - 61" W: 31"
 1 x 4 Watt Warm White LED
 Touch On-Off Switch
 Plug-In Driver
 Polished Stainless Steel Construction

B. **TD2200** Puck Shade
 C. **TD2213** Tent Shade
 Slim LED Task Lamp
 Adj H: 16" - 29" W: 31"
 1 x 4 Watt Warm White LED
 Touch On-Off Switch
 Plug-In Driver
 Polished Stainless Steel Construction

© 2011 TREND LIGHTING CORP®



· LED AC Driver can be removed and replaced if necessary.



· LED Unit is replaceable if necessary.

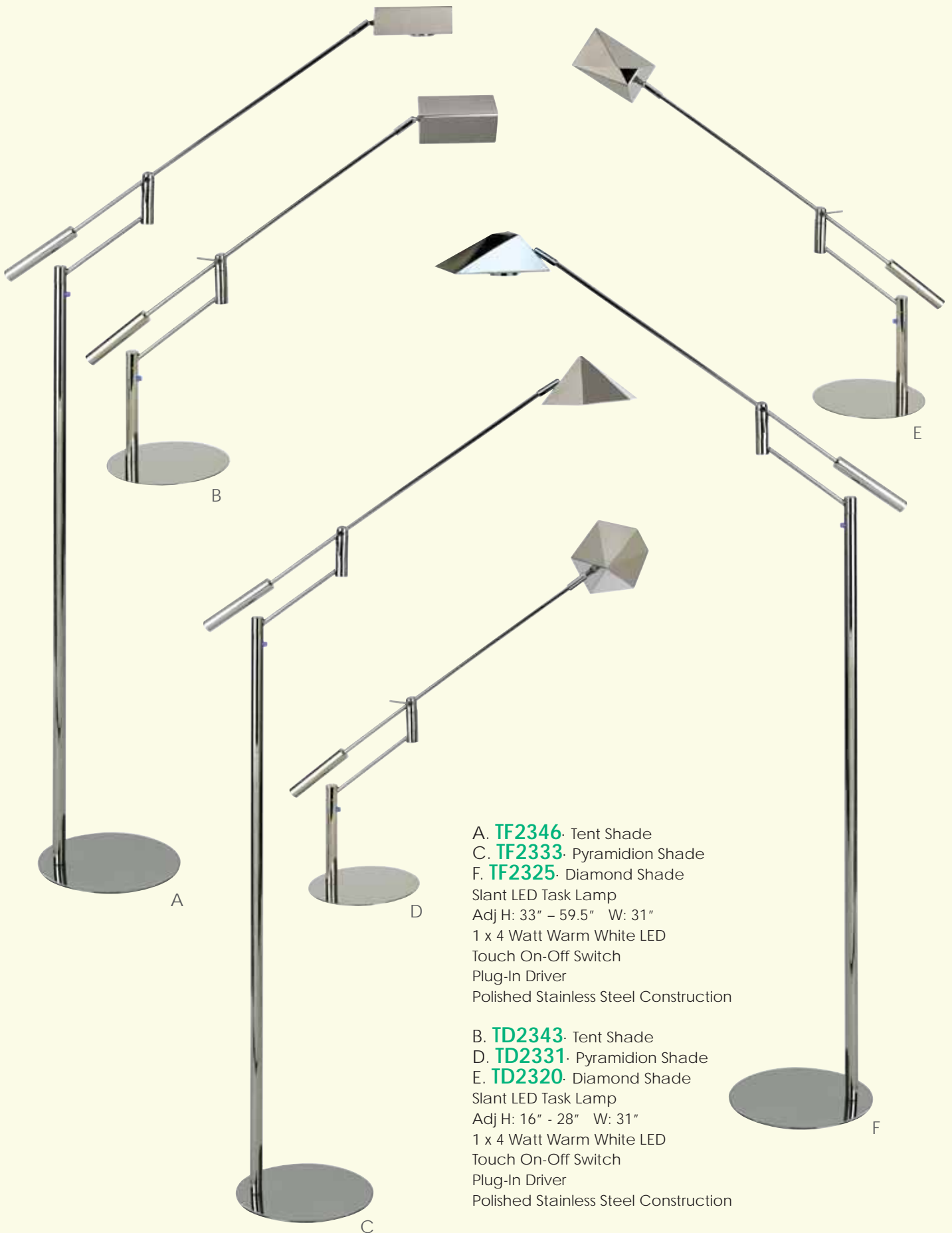

A. **TF2346** · Tent Shade
 C. **TF2333** · Pyramidion Shade
 F. **TF2325** · Diamond Shade
 Slant LED Task Lamp
 Adj H: 33" - 59.5" W: 31"
 1 x 4 Watt Warm White LED
 Touch On-Off Switch
 Plug-In Driver
 Polished Stainless Steel Construction

B. **TD2343** · Tent Shade
 D. **TD2331** · Pyramidion Shade
 E. **TD2320** · Diamond Shade
 Slant LED Task Lamp
 Adj H: 16" - 28" W: 31"
 1 x 4 Watt Warm White LED
 Touch On-Off Switch
 Plug-In Driver
 Polished Stainless Steel Construction

- LED Unit is replaceable if necessary.
- LED AC Driver can be removed and replaced if necessary.

A. **TF3635** Sphere Shade
 70" Soar LED Task Lamp
 Adj H: 42" – 66.5" W: 40"
 1 x 4 Watt Warm White LED
 Touch On-Off Switch
 Plug-In Driver
 Polished Stainless Steel Construction

B. **TD3630** Sphere Shade
 24" Soar LED Task Lamp
 Adj H: 14" – 31.5" W: 27"
 1 x 4 Watt Warm White LED
 Touch On-Off Switch
 Plug-In Driver
 Polished Stainless Steel Construction

C. **TD3620-26**
 Aesthetic Lamp
 16" H x 27.75" W
 2 x 60 Watt Incandescent
 or CFL Equivalent
 Polished Stainless Steel Construction
 US Patent D.436,206 S

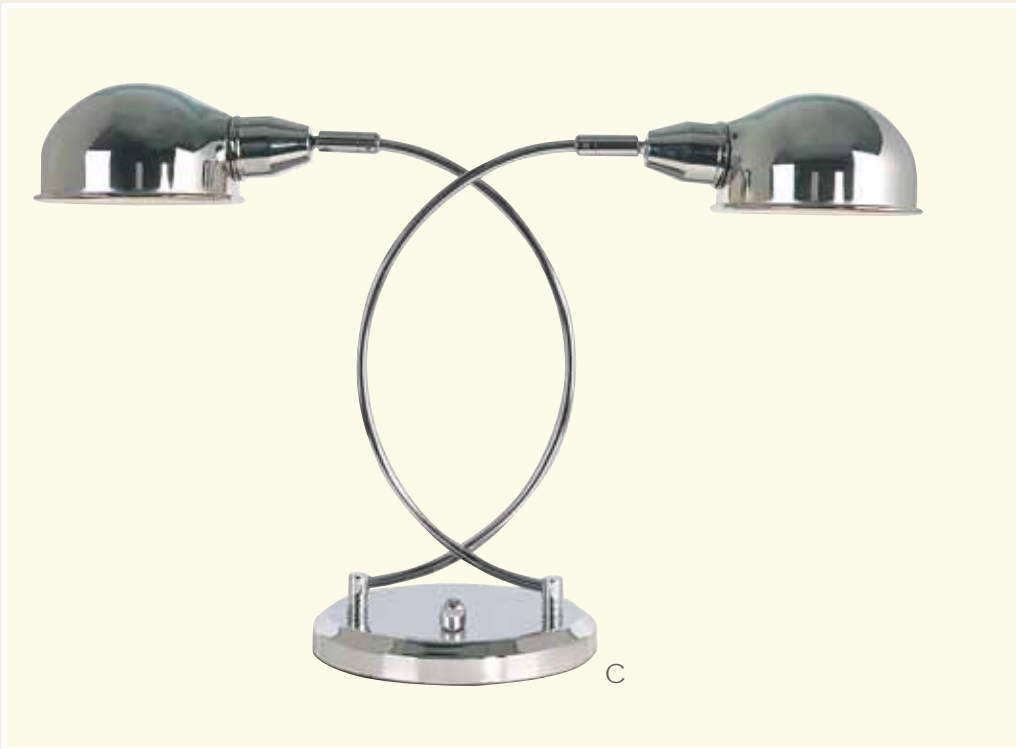
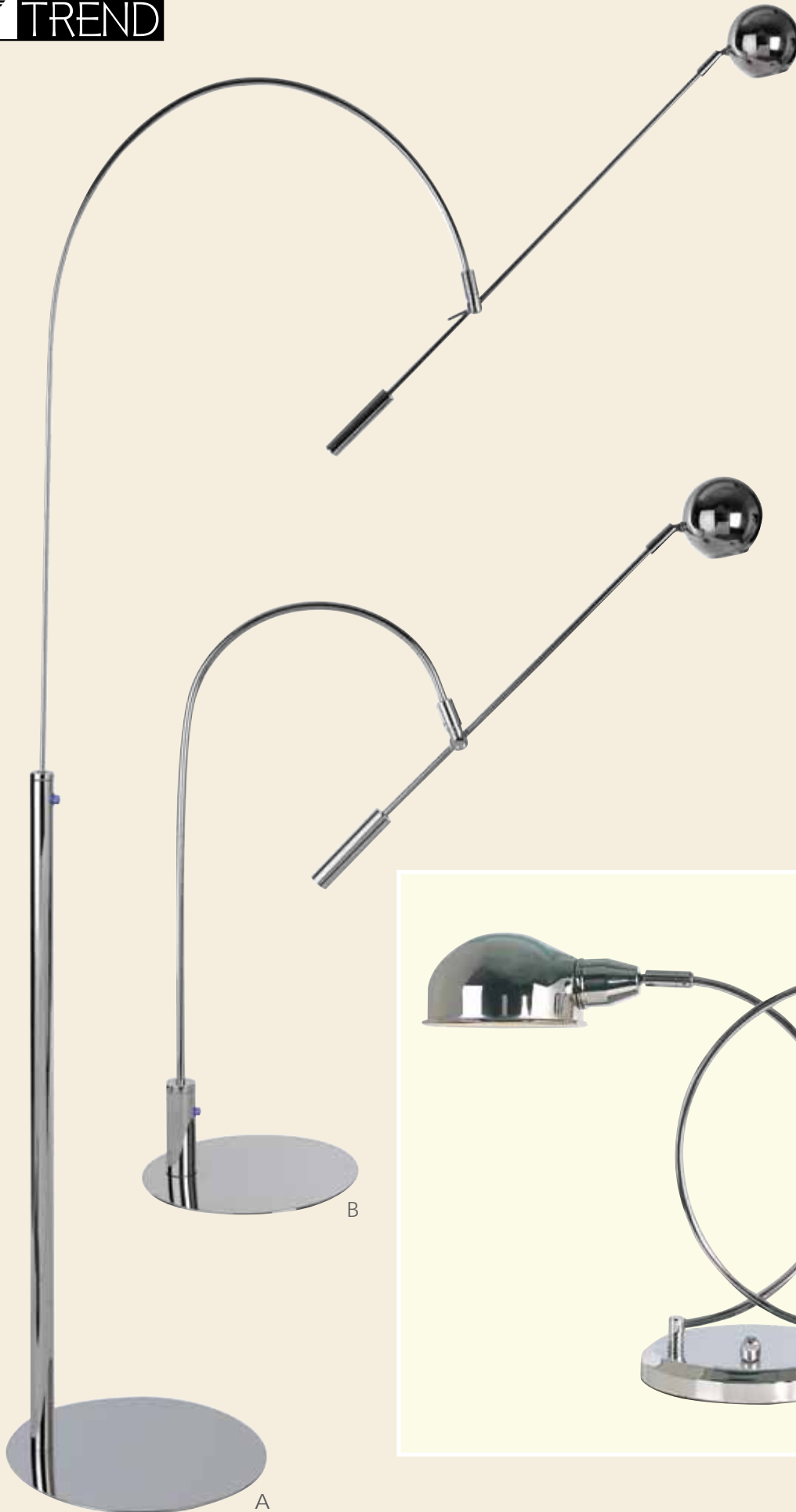

- LED Unit is replaceable if necessary.
- LED AC Driver can be removed and replaced if necessary.

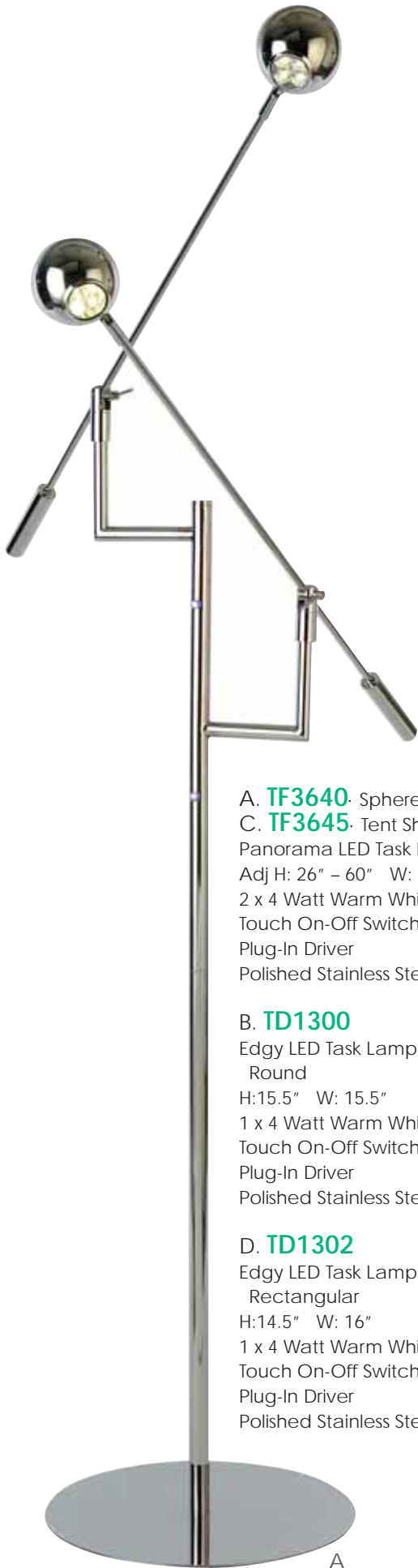

A. **TF3640** Sphere Shade
 C. **TF3645** Tent Shade
 Panorama LED Task Lamp
 Adj H: 26" – 60" W: 43"
 2 x 4 Watt Warm White LED
 Touch On-Off Switch
 Plug-In Driver
 Polished Stainless Steel Construction



B. **TD1300**
 Edgy LED Task Lamp
 Round
 H:15.5" W: 15.5"
 1 x 4 Watt Warm White LED
 Touch On-Off Switch
 Plug-In Driver
 Polished Stainless Steel Construction



D. **TD1302**
 Edgy LED Task Lamp
 Rectangular
 H:14.5" W: 16"
 1 x 4 Watt Warm White LED
 Touch On-Off Switch
 Plug-In Driver
 Polished Stainless Steel Construction

- LED Unit is replaceable if necessary.
- LED AC Driver can be removed and replaced if necessary.



A. TF1650

Linea Task Lamp
 Adjusts 35" – 69"
 16 Watt T4 Fluorescent Incl.
 Electronic Ballast
 Rocker Switch
 Satin Nickel Finish

B. TD1600

Linea Task Lamp
 Adjusts 13.5" – 32"
 16 Watt T4 Fluorescent Incl.
 Electronic Ballast
 Rocker Switch
 Satin Nickel Finish

C. TF568-07

Braccino Task Lamp
 46" Extension
 1 x 50 Watt Halogen Incl.
 Foot Switch
 Black Finish

D. TD560-07

Braccino Task Lamp
 30" Extension
 1 x 50 Watt Halogen Incl.
 Line Switch
 Black Finish

E. TF750-31

72" Triumph Torchiere
 2 x 100 Watt Incandescent
 Full Range Dimmer
 15" Satin Opal Glass
 Brushed Nickel Finish

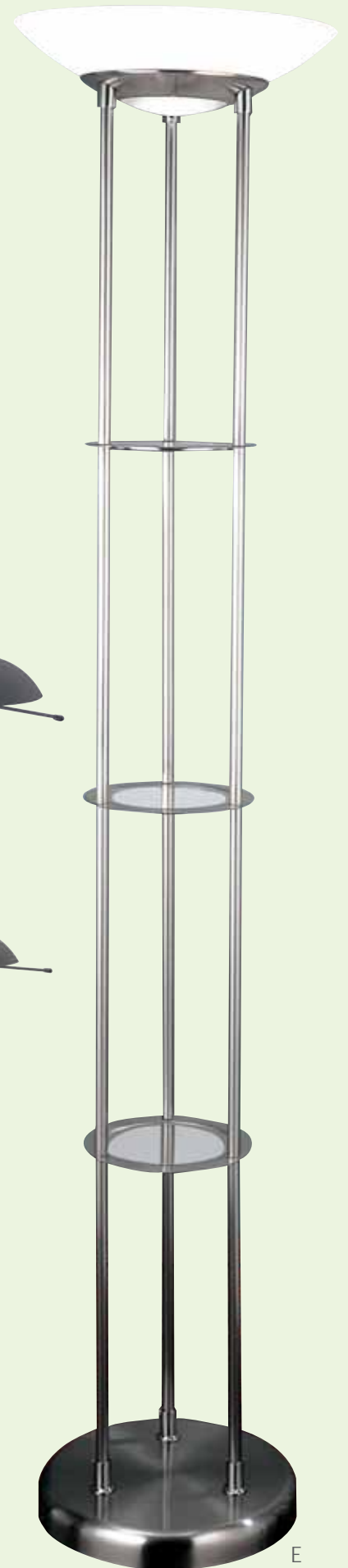



A



B



C

A. TF9010

UFO Lamp
 Shade Adjusts 57" – 67"
 3 x 40 Watt Incandescent
 or CFL Equivalent
 Foot Switch
 18" Satin Opal Glass
 Polished Chrome Finish

B. TF3627-08

Aesthetic Lamp
 47" H x 25.75" W
 2 x 60 Watt Incandescent
 or CFL Equivalent
 4-Way Switch
 Aged Brass Finish
 US Patent D.436,206 S

C. TFA9030

Triad Arc Lamp
 86" H x 48" Max Span
 55", 65", 75" Shade Clearance
 3 x 60 Watt Incandescent
 or Dimmable CFL Equivalent
 Foot Dimmer
 Black Marble Base
 Antique Bronze Finish



A



B



D



C

A. BF5535

61" Stilts Lamp
1 x 150 Watt Incandescent
or CFL Equivalent
17" Off-White Fiber Shade
Brushed Nickel Finish

B. TT2630

35" Tango Glass Lamp
1 x 100 Watt Incandescent
or CFL Equivalent
12" Oval Beige Waffle Linen Shade
Twilight Glass
Ebony Lacquer

C. TT7740

18" Ivory Cross Woven Linen Shade

D. TT7741

18" Golden Silk Shade
33" Rani Glass Lamp
1 x 150 Watt Incandescent
or CFL Equivalent
White Opal Glass
Ebony Lacquer



A



B



C



D

A. **TT7955**

18" Off-White Shantung Shade

B. **TT7953**

18" Black Parchment Shade

33.5" Luminous Lamp

1 x 150 Watt Incandescent

or CFL Equivalent

White Opal Glass

C. **TT7635** Sparkling Carmine

D. **TT7636** Sparkling Charcoal

30" Tinseltown Glass Lamp

1 x 100 Watt Incandescent

or CFL Equivalent

15" Off-White Shimmer Shade

Chiseled Relief Glass

Polished Chrome Finish



A



B



C



D



E

A. **TT5690**· Midnight
 B. **TT5695**· Crimson
 28" Kai Glass Lamp
 1 x 150 Watt Incandescent
 or CFL Equivalent
 16" Off-White Shantung Shade
 Ebony Lacquer

C. **TT5866**
 28" Harmony Glass Lamp
 1 x 150 Watt Incandescent
 or CFL Equivalent
 16" Off-White Shantung Shade
 Polished Chrome Finish

D. **TT3600**· Glacier White
 E. **TT3605**· Midnight
 26.5" Diva Glass Lamp
 1 x 150 Watt Incandescent
 or CFL Equivalent
 17" Ivory Cross Woven Linen Shade
 Ebony Lacquer



A

A. TT7947

36.5" Apex Glass Lamp
 1 x 150 Watt Incandescent
 or CFL Equivalent
 17" Cream Country Linen Shade
 Amber Hewn Glass
 Teak Finish

B. TT7946

36.5" Apex Glass Lamp
 1 x 150 Watt Incandescent
 or CFL Equivalent
 17" Opaque Black Linen Shade
 Clear Hewn Glass
 Satin Black Finish

C. TT7943

36.5" Apex Glass Lamp
 1 x 150 Watt Incandescent
 or CFL Equivalent
 17.5" Latte Linen Shade
 Clear Hewn Glass
 Satin Black Finish



B



C



A



B

A. TT6060

31" Coda Glass Lamp
 1 x 150 Watt Incandescent
 or CFL Equivalent
 18" Wheat Woven Linen Shade
 Clear Lucent Glass
 Pewter Leaf Finish

B. TT5785

30.5" Oceana Glass Lamp
 1 x 150 Watt Incandescent
 or CFL Equivalent
 17" Homespun Linen Shade
 Clear Reeded Glass
 Polished Chrome Finish

C. TT6101 · Opal White

D. TT6102 · Taupe
 31" Borden Taupe Glass Lamp
 1 x 150 Watt Incandescent
 or CFL Equivalent
 19" Cream Country Linen Shade
 Polished Chrome Finish



C



D



A. **TT7622** Apple Green
 B. **TT7625** Sepia
 31.5" Zen Glass Lamp
 1 x 150 Watt Incandescent
 or CFL Equivalent
 16" Ivory Cross Woven Linen Shade
 Chiseled Relief Glass
 Brushed Nickel Finish



C. **TT6220** Opal White
 D. **TT6223** Taupe
 27" Carina Taupe Glass Lamp
 1 x 150 Watt Incandescent
 or CFL Equivalent
 17" Homespun Linen Shade
 Polished Chrome Finish



C



D



A

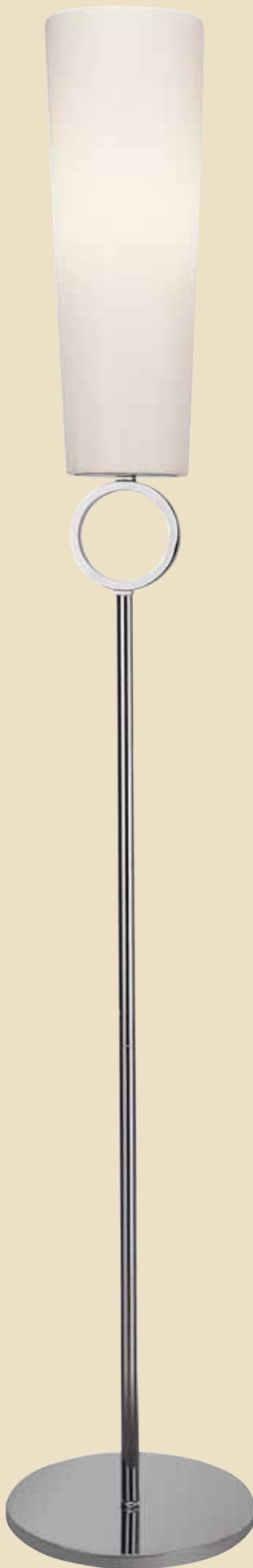

C

A. **TT7950**
Luminous Glass Lamp
23" H x 10" W
1 x 100 Watt Incandescent
Line Switch
Opal Glass
Brushed Nickel Finish

B. **TT6260**
Equinox Glass Lamp
24" H x 8" W
2 x 40 Watt Incandescent
Line Switch
Satin Opal Glass
Brushed Nickel Finish

C. **TF7969**
Pirouette Opal Glass Lamp
72" H x 11" W
1 x 150 Watt Incandescent
Line Switch
Polished Chrome Finish

D. **TT7960**
Pirouette Glass Lamp
28" H x 8" W
1 x 100 Watt Incandescent
Line Switch
Opal Glass
Polished Chrome Finish



D



B



A. TF7582

59.5" Apollo Glass Lamp
 3 x 60 Watt Incandescent
 or CFL Equivalent
 Foot Switch
 18" Pearl Glass Shade
 Polished Chrome Finish



B

B. TT5090

Fusion Glass Lamp
 36" H x 10" W
 1 x 100 Watt Incandescent
 Line Switch
 White Alabaster Glass w/
 Clear Fused Crystal Accent
 Brushed Nickel Finish



C. TT5092

28" Fusion Glass Lamp
 1 x 150 Watt Incandescent and
 1 x 25 Watt Incandescent
 or CFL Equivalent
 4-Way Switch
 17" White Linen Shade
 White Alabaster Glass
 Brushed Nickel Finish

D. TF5095

Fusion Glass Lamp
 70" H x 13" W
 1 x 100 Watt Incandescent
 Line Switch
 White Alabaster Glass w/
 Clear Fused Crystal Accent
 Brushed Nickel Finish



C

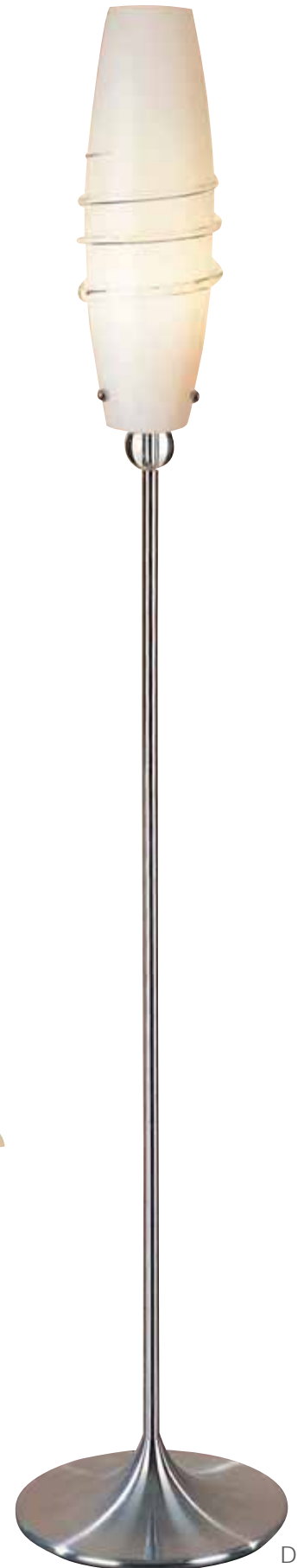

D



A

A. **TFA8960**
 Bordeaux Arc Lamp
 77" H x 38" W
 59" Shade Clearance
 1 x 150 Watt Incandescent
 or CFL Equivalent
 Foot Switch
 22" Oatmeal Linen Shade
 Black Marble Base
 Antique Bronze Finish



B

B. **TT6050**
 22.5" Virago Lamp
 2 x 60 Watt Incandescent
 or CFL Equivalent
 21" Off-White Shantung Shade
 Espresso Finish

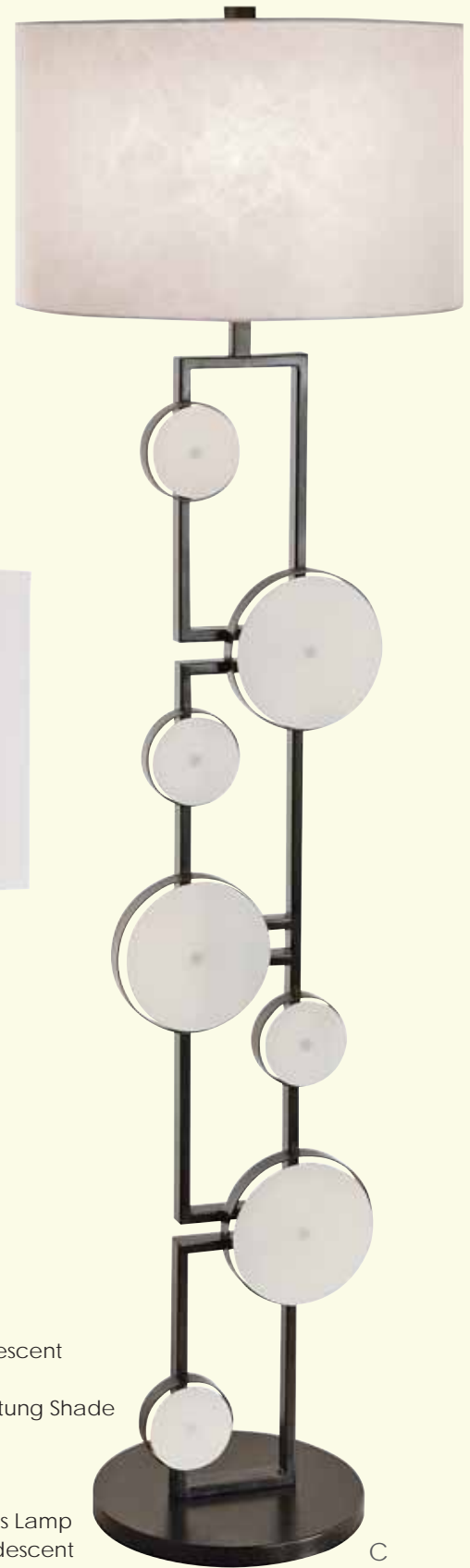

C

C. **TF5317**
 63" Spumante Glass Lamp
 1 x 150 Watt Incandescent
 or CFL Equivalent
 18" Ivory Marble Parchment Shade
 Weathered Slate Finish



A



C



B

- A. **TT5360-A** Amber
15" Twice Woven Cocoa Shade
- B. **TT5360-BB** Ebony
16" Onyx Sheen Shade
- C. **TT5360-WW** Ice
16" Silver Sheen Shade
- D. **TFA8965** Bordeaux Arc Lamp
77" H x 38" W
59" Shade Clearance
1 x 150 Watt Incandescent
or CFL Equivalent
Foot Switch
22" Cranberry Linen Shade
Black Marble Base

- A. **TT5360-A** Amber
15" Twice Woven Cocoa Shade
- B. **TT5360-BB** Ebony
16" Onyx Sheen Shade
- C. **TT5360-WW** Ice
16" Silver Sheen Shade
- D. **TFA8965** Bordeaux Arc Lamp
77" H x 38" W
59" Shade Clearance
1 x 150 Watt Incandescent
or CFL Equivalent
Foot Switch
22" Cranberry Linen Shade
Black Marble Base



A



B



C

A. TT5101

16" Onyx Sheen Shade

B. TT5100

16" Silver Sheen Shade

32" Dorian Glass Lamp
1 x 150 Watt Incandescent
or CFL Equivalent
Glacial Glass
Ebony Lacquer

C. TT6311

30.5" Destiny Glass Lamp
1 x 150 Watt Incandescent
or CFL Equivalent
16" Shantung Shade
Etched Relief Glass
Ebony Lacquer

D. TT5130

16" Silver Sheen Shade

E. TT5131

16" Onyx Sheen Shade
30.5" Dorian Glass Lamp
1 x 150 Watt Incandescent
or CFL Equivalent
Glacial Glass
Ebony Lacquer



D



E



A



B



C

A. **TT5213**
 11" Platinum Sheen Shade
 C. **TT5212**
 11" Onyx Sheen Shade
 33.5" Isis Ivory Glass Lamp
 1 x 150 Watt Incandescent
 or CFL Equivalent
 Ebony Lacquer

B. **TT5210**
 33.5" Isis Crimson Glass Lamp
 1 x 150 Watt Incandescent
 or CFL Equivalent
 11" Platinum Sheen Shade
 Ebony Lacquer

D. **TT1270**
 33" Polaris Glass Lamp
 1 x 150 Watt Incandescent
 or CFL Equivalent
 12" Cream Shantung Silk Shade
 Sahara Glass
 Brushed Nickel Finish

E. **TT6570**
 32" Carnival Glass Lamp
 1 x 150 Watt Incandescent
 or CFL Equivalent
 17" Off-White Vellum Shade
 Ebony Lacquer



D



E



A



B



C



D



E

A. **TT1243**
 31" Venetian Green Glass Lamp
 1 x 150 Watt Incandescent
 or CFL Equivalent
 16" Off-White Linen Shade
 Polished Chrome Finish

B. **TT5605** Amber
 C. **TT5607** Emerald
 30" La Bella Glass Lamp
 1 x 150 Watt Incandescent
 or CFL Equivalent
 15" Off-White Linen Shade
 Polished Chrome Finish

D. **TT2600** Seeded Clear
 E. **TT2603** Seeded Plum
 28" Arcadia Glass Lamp
 1 x 150 Watt Incandescent
 or CFL Equivalent
 16" Cream Shantung Shade
 Ebony Lacquer

A. **TT6312** · Cranberry
 18" Cinnamon Shantung Shade
 B. **TT6313** · Hunter Green
 18" Golden Shantung Shade
 32.5" Destiny Glass Lamp
 1 x 150 Watt Incandescent
 or CFL Equivalent
 Etched Relief Glass
 Ebony Lacquer

C. **TT7664** · Slate Terra Glass
 D. **TT7665** · Frosted Terra Glass
 30" Palisade Glass Lamp
 1 x 100 Watt Incandescent
 or CFL Equivalent
 16" Shantung Shade
 Ebony Lacquer

E. **TT6320**
 31.5" Eden Glass Lamp
 1 x 150 Watt Incandescent
 or CFL Equivalent
 20" Lattice Cream Linen Shade
 Polar White Glass
 Ebony Lacquer



A



B



C



D



E



A



B

A. TT6972
 32" Aramis Glass Lamp
 1 x 150 Watt Incandescent
 or CFL Equivalent
 19" Barley Linen Shade
 Sage Glass
 Antique Gold Finish

B. TT6970
 32" Aramis Glass Lamp
 1 x 150 Watt Incandescent and
 1 x 25 Watt Incandescent
 or CFL Equivalent
 4-Way Switch
 19" Off-White Vellum Shade
 Satin Opal Glass
 Satin Black Finish

C. TT3530
 31" Mocha Glass Lamp
 1 x 150 Watt Incandescent
 or CFL Equivalent
 20" Coarse Cream Linen Shade
 Hand Blown Shadow Glass
 Ebony Lacquer

D. TT3351-50
 33.5" Ballister Lamp
 1 x 150 Watt Incandescent
 or CFL Equivalent
 16" Cinnamon Sewn Shade
 Carved Wood
 Espresso Finish

E. TF6979
 70" Aramis Glass Lamp
 1 x 100 Watt Incandescent
 Foot Switch
 Satin Opal Glass
 Satin Black Finish



C



D

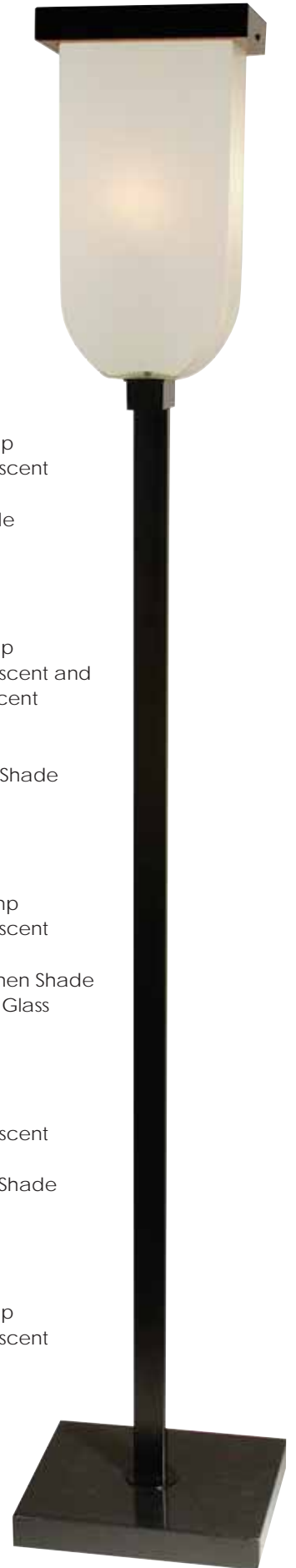

E

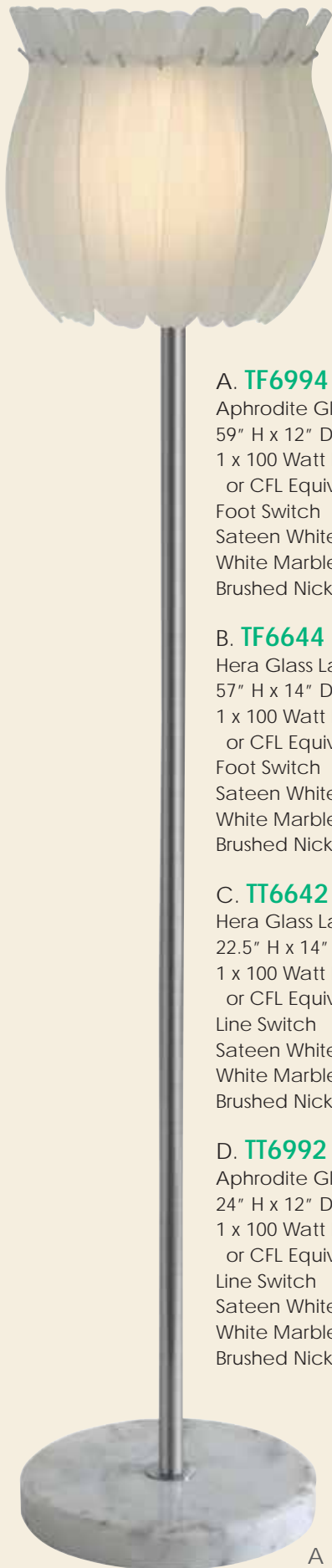

A. TF6994
 Aphrodite Glass Lamp
 59" H x 12" Dia
 1 x 100 Watt Incandescent
 or CFL Equivalent
 Foot Switch
 Sateen White Glass
 White Marble Base
 Brushed Nickel Finish



B. TF6644
 Hera Glass Lamp
 57" H x 14" Dia
 1 x 100 Watt Incandescent
 or CFL Equivalent
 Foot Switch
 Sateen White Glass
 White Marble Base
 Brushed Nickel Finish

C. TT6642
 Hera Glass Lamp
 22.5" H x 14" Dia
 1 x 100 Watt Incandescent
 or CFL Equivalent
 Line Switch
 Sateen White Glass
 White Marble Base
 Brushed Nickel Finish

D. TT6992
 Aphrodite Glass Lamp
 24" H x 12" Dia
 1 x 100 Watt Incandescent
 or CFL Equivalent
 Line Switch
 Sateen White Glass
 White Marble Base
 Brushed Nickel Finish



C



D



A. TF6963

Aphrodite Glass Lamp
 60" H x 18" Dia
 2 x 75 Watt Incandescent
 Foot Switch
 Sateen White Glass
 White Marble Base
 Brushed Nickel Finish

B. TF6962

Aphrodite Glass Lamp
 28" H x 14" Dia
 2 x 60 Watt Incandescent
 Line Switch
 Sateen White Glass
 White Marble Base
 Brushed Nickel Finish

C. TF6943

Hera Glass Lamp
 60" H x 20.5" Dia
 1 x 100 Watt Incandescent
 Foot Switch
 Sateen White Glass
 White Marble Base
 Brushed Nickel Finish





A. TFA9005

Mid Arc Lamp
 85" – 89" Ht
 84" – 87" Ext
 46" – 53" Shade Clearance
 1 x 150 Watt Incandescent
 or Dimmable CFL Equivalent
 Foot Dimmer
 White Marble Base
 Brushed Nickel Finish

B. TT5930

27" Cerise Lamp
 1 x 150 Watt Incandescent
 or CFL Equivalent
 16" Off-White Linen Shade
 Polished Chrome Finish

C. TFA8005

Mid Arc Lamp
 69" – 74" Ht
 49" – 52" Ext
 52" – 55" Shade Clearance
 1 x 150 Watt Incandescent
 or Dimmable CFL Equivalent
 Foot Dimmer
 White Marble Base
 Brushed Nickel Finish



A. **TFA9901**
 Chelsea Arc Lamp
 84.5" H x 82" W
 62.5" Shade Clearance
 2 x 100 Watt Incandescent
 or Dimmable CFL Equivalent
 Foot Dimmer
 20" Lattice Cream Linen Shade
 White Marble Base
 Polished Chrome Finish

B. **TT7900-G** Sheer Gold Ribbon Shade
 Antique Gold Finish
 C. **TT7900-W** Sheer Pearl Ribbon Shade
 Brushed Nickel Finish
 18" H x 18" W Shanghai Lamp
 1 x 60 Watt Incandescent
 or CFL Equivalent

D. **TFA9900**
 Chelsea Arc Lamp
 84.5" H x 82" W
 62.5" Shade Clearance
 2 x 100 Watt Incandescent
 or Dimmable CFL Equivalent
 Foot Dimmer
 20" Ash Woven Linen Shade
 White Marble Base
 Polished Chrome Finish



A. **TFA7768-S**
 22" Checkedred Prism Shade
 B. **TFA7768-B**
 22" Smoke Shade
 Paparazzi Arc Lamp
 87" - 93" Ht
 78" - 89" Ext
 48" - 65" Shade Clearance
 1 x 150 Watt Incandescent
 or Dimmable CFL Equivalent
 Foot Dimmer
 Shaded Mirror Two Tier Shade
 White Marble Base
 Brushed Nickel Finish

C. **TT3404**
 32" Two Face Lamp
 2 x 75 Watt Incandescent
 Line Switch
 20" Black Parchment Shade
 Ebony Lacquer



A. TFA9200

Astoria Arc Lamp
84" H x 36" W
49" Shade Clearance
3 x 100 Watt Incandescent
or Dimmable CFL Equivalent
Floor Dimmer
3 Tier Shade : Bone Kinwashi Shade
Black Marble Base
Brushed Nickel Finish

B. TT9202

Astoria Arc Lamp
32" H x 22" W
1 x 100 Watt Incandescent
Line Switch
3 Tier Shade : Bone Kinwashi Shade
Black Marble Base
Brushed Nickel Finish



A. TFA9300

Astoria Arc Lamp
 83" H x 86" W
 67" Shade Clearance
 3 x 60 Watt Incandescent
 or CFL Equivalent
 4-Way Switch
 3 Tier Shade : Bone Kinwashi Shade
 Black Marble Base
 Brushed Nickel Finish

B. TF2839

Cerberus Lamp
 80" Max Adjustable Height
 3 x 60 Watt Incandescent
 or CFL Equivalent
 4-Way Switch
 Coarse Cream Linen Shade
 Black Marble Base
 Polished Chrome Finish

A

B



A. **TF3977-W**
69" Pique Oval Lamp
1 x 150 Watt Incandescent
Foot Switch
22" Eco Synthetic White Petal Shade
Brushed Nickel Finish



B. **TT3963-W**
19" Pique Lamp
1 x 100 Watt Incandescent
Line Switch
18" Eco Synthetic White Petal Shade
Metallic Silver Finish

C. **TF3966-W**
66" Pique Round Lamp
1 x 100 Watt Incandescent
Foot Switch
19" Eco Synthetic White Petal Shade
Metallic Silver Finish





A. TT7923

18" Golden Silk Shade

B. TT7922

17.5" Latte Linen Shade

33" Midas Glass Lamp

1 x 150 Watt Incandescent
or CFL Equivalent

Gold Glass w/

Painted Chiseled Relief
Brushed Nickel Finish

C. TFA3976-W

Pique Arc Lamp

85" - 90" Ht

88" - 88" Ext

53" - 65" Shade Clearance

1 x 150 Watt Incandescent
or Dimmable CFL Equivalent

Foot Dimmer

22" Eco Synthetic White Petal Shade

White Marble Base

Brushed Nickel Finish



A. TF1278
60" Titan Lamp
1 x 150 Watt Incand.
or CFL Equivalent
16" Combed Linen Shade
Sahara Glass w/
Crystal Accents Ebony Lacquer

B. TT1276
33" Titan Lamp
1 x 150 Watt Incand.
or CFL Equivalent
16" Combed Linen Shade
Sahara Glass w/
Crystal Accents Ebony Lacquer

C. TF7728
62.5" Prestige Glass Lamp
2 x 60 Watt Incand.
Foot Switch
22" Latte Linen Shade
Candy Glass
Ebony Lacquer

A

B

C



A

A. TT7720

32" Prestige Glass Lamp
2 x 60 Watt Incandescent
Line Switch
22" Latte Linen Shade
Candy Glass
Ebony Lacquer



B

B. TT7572

37" Linque Lamp
1 x 150 Watt Incandescent
or CFL Equivalent
17" Lattice Cream Linen Shade
Antique Gold Finish



C

C. TF7576

64" Linque Lamp
1 x 150 Watt Incandescent
or CFL Equivalent
20" Lattice Cream Linen Shade
Antique Gold Finish



A



B



C

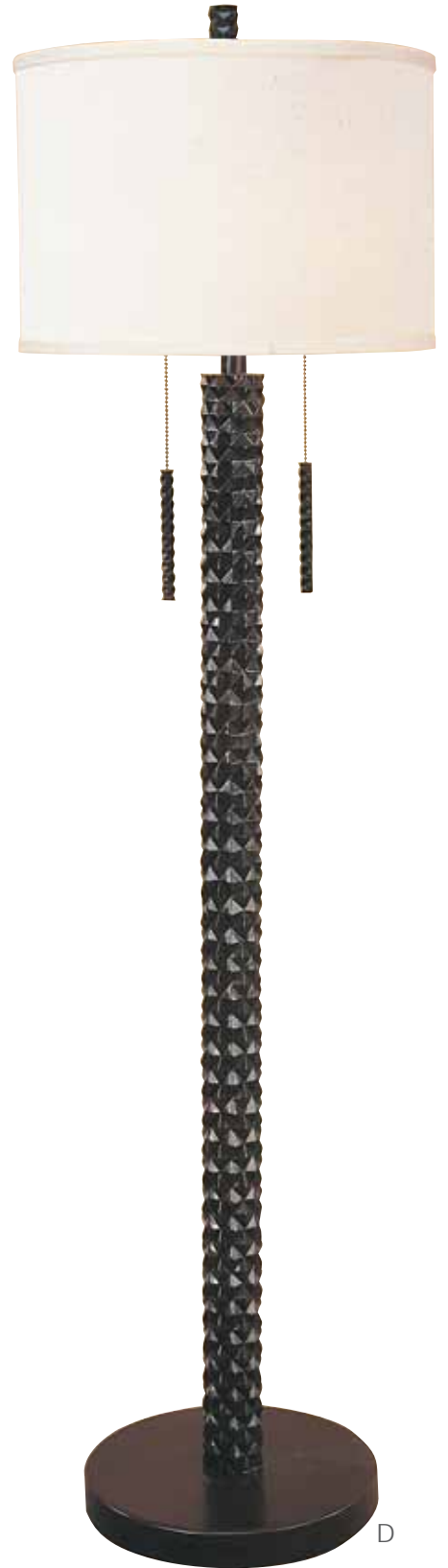

D

A. **TF6229**

64" Marquis Glass Lamp
1 x 150 Watt Incandescent
or CFL Equivalent
17" Antique Marble Parchment Shade
Bronze Terra Glass
Antique Bronze Finish

B. **TT6226**

33.5" Marquis Glass Lamp
1 x 150 Watt Incandescent
or CFL Equivalent
17" Antique Marble Parchment Shade
Bronze Terra Glass
Antique Bronze Finish

C. **TT6630**

32" Pina Lamp
2 x 100 Watt Incandescent
or CFL Equivalent
Pull Chain
15" Cream Country Linen Shade
Carved Wood
Dark Cherry Wood Finish

D. **TF6639**

61" Pina Lamp
2 x 100 Watt Incandescent
or CFL Equivalent
Pull Chain
16" Cream Country Linen Shade
Carved Wood
Dark Cherry Wood Finish



E



F

E. **TT5953**

27" Hitari Glass Lamp
1 x 150 Watt Incandescent
or CFL Equivalent
13" Ivory Sail Cloth Shade
Calico Glass
Walnut Finish

F. **TT7210**

40" Haiku Glass Lamp
1 x 75 Watt Incandescent
or CFL Equivalent
Line Switch
10" Lattice Cream Shade
Etched Relief Glass
Walnut Finish

G. **TF7217**

63" Haiku Glass Lamp
1 x 100 Watt Incandescent
or CFL Equivalent
Foot Switch
12" Lattice Cream Shade
Etched Relief Glass
Walnut Finish



G



A



B



C



D

A. TF6239

59.5" Arpeggio Lamp
2 x 100 Watt Incandescent
or CFL Equivalent
Pull Chain
17" Off-White Linen Shade
Walnut/Brushed Nickel Finish

B. TT6230

27" Arpeggio Lamp
2 x 100 Watt Incandescent
or CFL Equivalent
Pull Chain
15" Off-White Linen Shade
Walnut/Brushed Nickel Finish

C. TT3430-31. Maple Striated
Brushed Nickel Finish

D. TT3430-38. Dark Walnut
Hand Rubbed Brass Finish
33" Doric Lamp
1 x 150 Watt Incandescent
or CFL Equivalent
13.5" Coarse White Linen Shade

E. TT5753

30" Sinatra II Lamp
2 x 100 Watt Incandescent
or CFL Equivalent
Pull Chain
16" Off-White Coarse Linen Shade
Dark Walnut/Brushed Nickel Finish

F. TT5750

27" Sinatra II Lamp
1 x 150 Watt Incandescent
or CFL Equivalent
14" Off-White Coarse Linen Shade
Dark Walnut/Brushed Nickel Finish

G. TT4157

32" Crescent Lamp
1 x 150 Watt Incandescent
or CFL Equivalent
18" Homespun Linen Shade
Weathered Walnut/
Brushed Nickel Finish

H. TT4150-03

31" Aspen Lamp
1 x 150 Watt Incandescent
or CFL Equivalent
16" Homespun Linen Shade
Antique Bronze w/ Black Finish

I. TF5755

61" Sinatra II Lamp
2 x 100 Watt Incandescent
or CFL Equivalent
Pull Chain
16" Off-White Coarse Linen Shade
Dark Walnut/Brushed Nickel Finish



E



F



I



G



H



A



B



C



D

A. TF170-38

Hand Rubbed Brass Finish

B. TF170-39

Aged Brass Finish

Granier Lamp

Adjusts 46" – 59"

1 x 150 Watt Incandescent
or CFL Equivalent

17" Off White Linen Shade

C. TT168-38

Hand Rubbed Brass Finish

D. TF168-39

Aged Brass Finish

Granier Lamp

Adjusts 26" – 32"

1 x 150 Watt Incandescent
or CFL Equivalent

15" Off White Linen Shade

E. TF5437

59.5" Striations Lamp

1 x 150 Watt Incandescent
or CFL Equivalent

20" Cream Country Linen Shade

Antique Copper Finish

F. TT5723

30" Pinot Lamp

1 x 150 Watt Incandescent
or CFL Equivalent

15" Cream Country Linen Shade

Terra Cotta Marble Accent

Aged Brass Finish

G. TT5640

31.5" Domicile Lamp

1 x 150 Watt Incandescent
or CFL Equivalent

18" Cream Country Linen Shade

Terra Cotta Marble Accent

Antique Bronze Finish

H. TT5430

30.5" Striations Lamp

1 x 150 Watt Incandescent
or CFL Equivalent

17" Cream Country Linen Shade

Antique Copper Finish

I. TT5655

31" Artemis Lamp

1 x 150 Watt Incandescent
or CFL Equivalent

18" Cream Country Linen Shade

Terra Cotta Marble Accent

Antique Bronze Finish



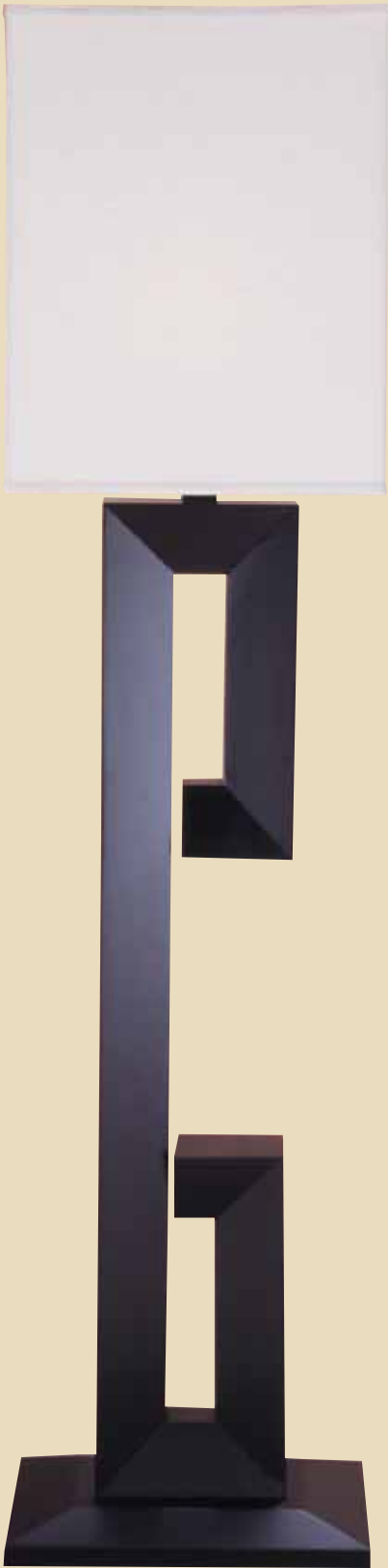

A



B



C



D

A. TF3368-50

60" Urban II Lamp
1 x 150 Watt Incandescent
or CFL Equivalent
16" Flax Fabric Shade
Espresso Finish



E

B. TF4216

59" Gustavian Lamp
1 x 150 Watt Incandescent
or CFL Equivalent
15" Homespun Linen Shade
Bronze Finish



F

C. TT4202

29" Gustavian Lamp
1 x 150 Watt Incandescent
or CFL Equivalent
15" Homespun Linen Shade
Bronze Finish

D. TT3364-50

39" Urban II Lamp
1 x 150 Watt Incandescent
or CFL Equivalent
16" Flax Fabric Shade
Espresso Finish

E. TT4080

28.5" Wave II Lamp
1 x 150 Watt Incandescent
or CFL Equivalent
17.5" Latte Linen Shade
Aged Brass Finish



G

F. TT3361-50

29" Saucer Lamp
1 x 150 Watt Incandescent
or CFL Equivalent
16" Tan Pattern Shade
Espresso Finish



H

G. TT3378-50

33" Rollo Lamp
1 x 150 Watt Incandescent
or CFL Equivalent
16" Homespun Linen Shade
Espresso Finish

H. TT3377-50

29" Balance Lamp
2 x 100 Watt Incandescent
or CFL Equivalent
17" Cross Pattern Shade
Espresso Finish/
Brushed Nickel Finish



A



B



C



D

A. TF499

Crossfire Crystal Lamp
64" H x 11" W
3 x 20 Watt Halogen Incl.
Polished Chrome Finish

B. TF5875

60" Palla Crystal Lamp
2 x 100 Watt Incandescent
or CFL Equivalent
Pull Chain
16" White Linen Shade
Polished Chrome Finish

C. TT5800

29" Palla Crystal Lamp
2 x 100 Watt Incandescent
or CFL Equivalent
Pull Chain
16" White Linen Shade
Polished Chrome Finish

D. TA5850

20" Palla Crystal Lamp
1 x 75 Watt Incandescent
or CFL Equivalent
10" White Linen Shade
Polished Chrome Finish



A

A. TT5864

32" Clarity II Crystal Lamp
1 x 150 Watt Incandescent
or CFL Equivalent
16" Ivory Kinwashi Shade
Polished Chrome Finish



B

B. TT5862

31" Clarity Crystal Lamp
1 x 100 Watt Incandescent
or CFL Equivalent
7" Hand Sewn Shade
Polished Chrome Finish



C

C. TA8780

20" Cascades Crystal Lamp
1 x 60 Watt Incandescent
or CFL Equivalent
7" Hand Sewn Shade
Polished Chrome Finish

D. TT8723

32.5" Tableau Crystal Lamp
1 x 150 Watt Incandescent
or CFL Equivalent
17" Platinum Sheen Shade
Polished Chrome Finish



D



A

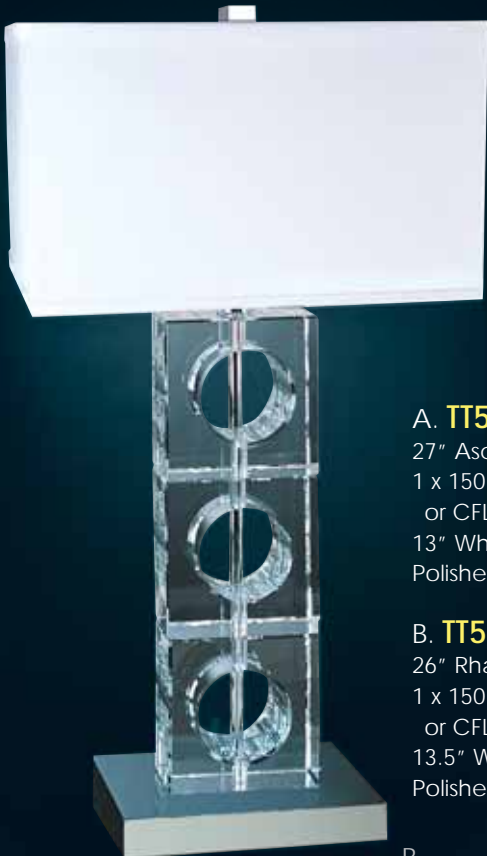

B



C



D

A. TT5630
 27" Ascention II Crystal Lamp
 1 x 150 Watt Incandescent
 or CFL Equivalent
 13" White Linen Shade
 Polished Chrome Finish

B. TT5632
 26" Rhapsody Crystal Lamp
 1 x 150 Watt Incandescent
 or CFL Equivalent
 13.5" White Linen Shade
 Polished Chrome Finish

C. TT5808
 30" Pallaeh Crystal Lamp
 2 x 75 Watt Incandescent
 or CFL Equivalent
 Pull Chain
 16" White Linen Shade
 Polished Chrome Finish

D. TT5809
 59" Pallaeh Crystal Lamp
 2 x 100 Watt Incandescent
 or CFL Equivalent
 Pull Chain
 16" White Linen Shade
 Polished Chrome Finish



A

A. TF5928

62" Facetnation Crystal Lamp
 2 x 100 Watt Incandescent
 or CFL Equivalent
 Pull Chain
 16" White Linen Shade
 Polished Chrome Finish

B. TT5925

28" Facetnation Crystal Lamp
 2 x 60 Watt Incandescent
 or CFL Equivalent
 Pull Chain
 15" White Linen Shade
 Polished Chrome Finish



B



C

C. TT5636

27" Ruminations Crystal Lamp
 1 x 150 Watt Incandescent
 or CFL Equivalent
 16" Off-White Shantung Shade
 Polished Chrome Finish



D

D. TT5639

27" Ruminations Crystal Lamp
 1 x 150 Watt Incandescent
 or CFL Equivalent
 15" Horizontal Crystal Pleat Shade
 Polished Chrome Finish



A



B



C

A. TT8788

31" Cascades Crystal Lamp
1 x 150 Watt Incandescent
or CFL Equivalent
16" Ivory Kinwashi Shade
Polished Chrome Finish

B. TT5868

33" Uprising Crystal Lamp
2 x 75 Watt Incandescent
or CFL Equivalent
Pull Chain
16" White Egyptian Linen Shade
Polished Chrome Finish

C. TT8730

31" Three Kings Crystal Lamp
1 x 150 Watt Incandescent
or CFL Equivalent
16" Onyx Sheen Shade
w/ Silver Lining
Polished Chrome Finish



A

A. TT8700

30" Solitaire Crystal Lamp
 1 x 150 Watt Incandescent
 or CFL Equivalent
 17" Ivory Silk Shade
 Polished Chrome Finish



B

B. TT8712

32" Etoile Crystal Lamp
 1 x 150 Watt Incandescent
 or CFL Equivalent
 20" Ivory Silk Shade
 Polished Chrome Finish



A

A. TT5895

26.5" Abstractions Crystal Lamp
 1 x 150 Watt Incandescent
 or CFL Equivalent
 13.5" Sheer Snow/Shantung Shade
 Polished Chrome Finish



C

B. TT5869

31" Eloquence Crystal Lamp
 1 x 150 Watt Incandescent
 or CFL Equivalent
 20" White Egyptian Shade
 Polished Chrome Finish



B

C. TT5879

34.5" Vanguard Crystal Lamp
 1 x 150 Watt Incandescent
 or CFL Equivalent
 16" White Egyptian Shade
 Polished Chrome Finish



A

A. TT8735

31" Three Kings Crystal Lamp
 1 x 150 Watt Incandescent
 or CFL Equivalent
 16" Onyx Sheen Shade
 w/ Gold Lining
 Polished Brass Finish

B. TT8713

34.5" Etoile Crystal Lamp
 1 x 150 Watt Incandescent
 or CFL Equivalent
 16" Onyx Sheen Shade
 w/ Gold Lining
 Polished Brass Finish



B



A



B

A. TT5860

28" Lune Crystal Lamp
1 x 150 Watt Incandescent
or CFL Equivalent
16" Off-White Shantung Shade
Polished Chrome Finish

B. TT5702

25" Bedside Crystal Lamp
1 x 150 Watt Incandescent
or CFL Equivalent
13" White Shantung Shade
Polished Chrome Finish



C



D

C. TT5840

29.5" Quattro Crystal Lamp
2 x 100 Watt Incandescent
or CFL Equivalent
Pull Chain
16" White Linen Shade
Polished Chrome Finish

D. TT5810

29.5" Palla IV Crystal Lamp
1 x 150 Watt Incandescent
or CFL Equivalent
15" White Linen Shade
Polished Chrome Finish



A



C



B

A. TT5884

29" Visions Crystal Lamp
1 x 150 Watt Incandescent
or CFL Equivalent
17" Platinum Sheen Shade
Polished Chrome Finish

B. TT5886

28" Classic Visions Crystal Lamp
2 x 75 Watt Incandescent
or CFL Equivalent
Pull Chain
16" Off-White Shantung Shade
Polished Chrome Finish

C. TT5885

29" Balance Visions Crystal Lamp
1 x 150 Watt Incandescent
or CFL Equivalent
16" Off-White Shantung Shade
Polished Chrome Finish

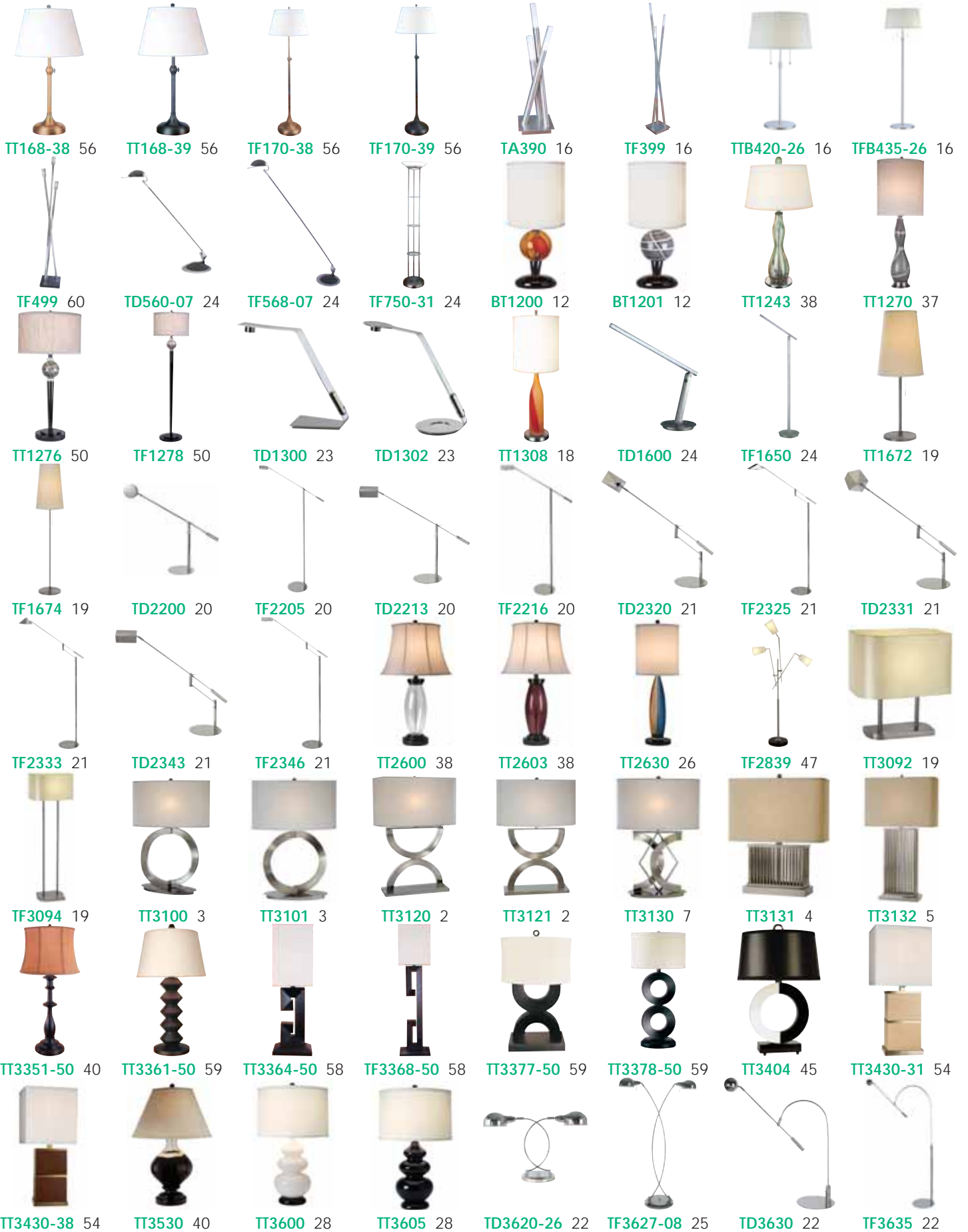

© 2011 TREND LIGHTING CORP®





TF5875 60



TT5879 66



TT5884 69



TT5885 69



TT5886 69



TT5895 66



TT5925 63



TF5928 63



TT5930 43



TT5953 53



BA6000 18



BA6002 18



BA6003 18



TT6050 34



TT6060 30



TT6101 30



TT6102 30



TT6220 31



TT6223 31



TT6226 52



TF6229 52



TT6230 54



TF6239 54



TT6260 32



TT6311 36



TT6312 39



TT6313 39



TT6320 39



TT6570 37



TT6630 52



TF6639 52



TT6642 41



TF6644 41



TF6943 42



TT6962 42



TF6963 42



TT6970 40



TT6972 40



TF6979 40



TT6992 41



TF6994 41



BT7100-S 14



BT7100-W 15



BT7102-S 14



BT7102-W 15



BF7103-S 14



BF7103-W 15



BW7105-S 15



BW7105-W 15



BT7143 13



BF7145 13



BT7151 17



BF7153 17



BW7155 13



BT7162 12



BF7164 12



BT7173-SB 14



TT7210 53



TF7217 53



TT7300 6



TF7305 6



TT7570 5



TT7572 51



TT7574 4



© 2011 TREND LIGHTING CORP®



TREND LIGHTING CORPORATION®

4821 4TH ST. IRWINDALE, CA 91706 • T: (626) 480-8880 • F: (626) 480-8850

SHOWROOMS: LAS VEGAS C-1089 • HIGH POINT H204 • DALLAS TM4931 • IRWINDALE, CA
INFO@TLIGHTING.COM WWW.TLIGHTING.COM

**american
lighting
association**

All Designs and Images © 2011 Trend Lighting ® All Rights Reserved.

LIGHTING PORTABLE COLLECTION
022011 \$20