

WATERFORD
 LIGHTING

NEW LISMORE
 9 ARM CHANDELIER
 950 000 3611 W 110V

CAUTION

- Before any work is started, ensure that the electricity supply has been switched off at the main fuse box. Read the instructions carefully and check parts supplied against contents list.
- **A qualified electrical contractor** should be employed to install this chandelier. The ceiling installation should be tested to at least three times the weight of the chandelier and chain. In the interest of safety the anchorage, chain and chandelier should be regularly inspected.
- It is of the upmost importance that the bracket is securely attached to the ceiling before commencing installation of chandelier.
- When cleaning or replacing chandelier bulbs please ensure that it is switched off at mains
- If the external cable or cord is damaged, please contact Waterford Crystal customer care to replace / repair the defective item.

Photograph of chandelier



Contents of packaging:

Item	Identification Mark	Number of pcs
Suspension Set	I	1
Rod and plate assembly	II	1
Chrome Spacer	5	1
B6 7" Lismore – 901 318 5800	40	1
C20 Rod – 903 318 6700	41	2
Holder – 119008	42	9
Chandelier Arm – 900 599 6600	43	3
A34 Arm – 900 318 6700	44	6
B8 End Bowl – 901 318 6600	45	1
Carina 2,5" Finial – 037 190 5100	46	1
Bulbs 40W/130V – E12	621	9
Wire Connectors	110,111	7
** Trimmings		

***Trimmings list – See last page*

Certificates of the light fitting:

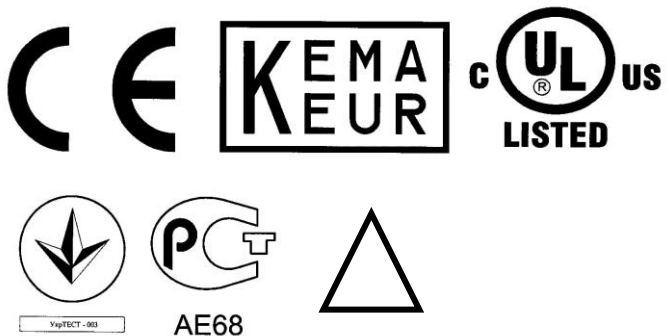

1.

Ensure power supply is off at the mains.

- Prepare the Anchorage point in the ceiling. The ceiling installation should be tested to at least three times the weight of the chandelier and chain.
- Determine the height at which the chandelier is to hang and adjust the length of the chain accordingly.
- The metal centre rod and plate are factory assembled and threaded with flexible cable.
- **Remove** the loop (1), nut (12), slip-on tube (11), washers (11) & (6-3pcs), from the upper portion of the centre rod (3)
- **Assemble** crystal part and washer as shown below - (41,6), chrome spacer 5, washer and crystal part (6,41), washer (6), top bowl (40), washer (4), slip-on tube (11).
- Carefully replace nut (12), loop (1) to the threaded part of the centre rod (3) as far as it will go (hand tighten ONLY)
- Secure it in position with locking screw (2), using the allen key (hand tighten ONLY).

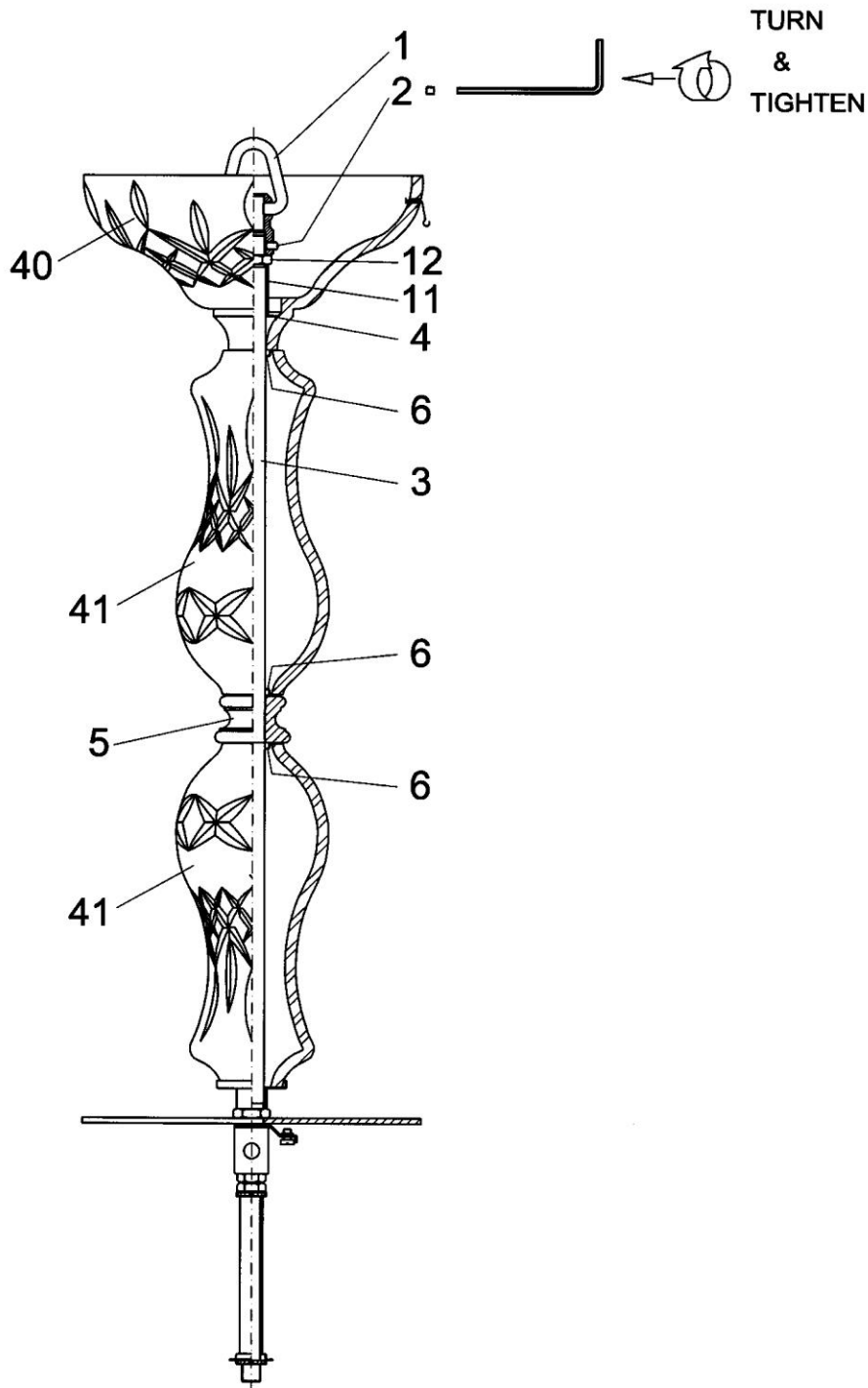

2.

Electric Ceiling Connection

- **Release** the screw (104) on the canopy (103) and lower it along the chain (101).
- **Pass** bar (108) through the suspending fillet (105). Now pass bolt (109) through hole in part (108) Fig (A) and lock with two nuts as shown.
- **Attach** the suspending fillet (105) to the ceiling anchorage using suitable screws (Not supplied).
- **Gently pull** the supply cable from the light fitting and loop through the suspending chain (101) and then through the opening in the canopy (103).
- **Insert** cable terminals Live, Neutral & Earth into block connector (111) and tighten screws.
- **Insert** supply cable terminals Live, Neutral & Earth into corresponding slots (111) and tighten screws
- **Push** the canopy (103) up to the ceiling and fix it with the adjusting screw (104). Ensure all wires are safely hidden.

Use Hook To Support Chain, Not Electrical Cord.

Le Crochet Doit Supporter La Chaîne Et Non Le Cordon lectrique.

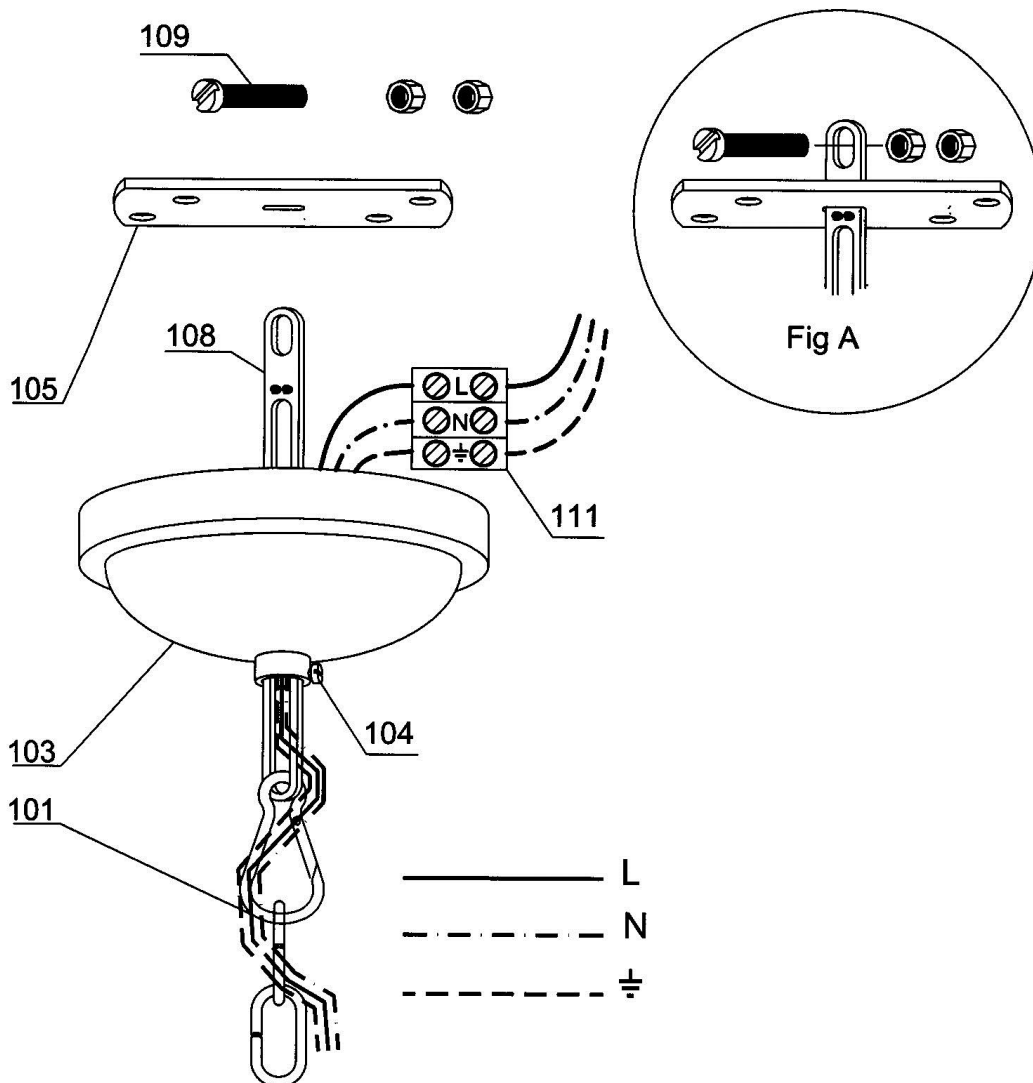

IF THE EXTERNAL CABLE OR CORD IS DAMAGED THEN PLEASE CONTACT WATERFORD CRYSTAL CUSTOMER CARE TO REPLACE / REPAIR THE DEFECTIVE ITEM

3.

- **Insert and fix** each arm (43) & (44) in its position and secure with its hex nut (24), hand tight (2Nm).

N.B 5.2.6 The number of connectors shall not exceed 5 when using a twist-on wire connector for field wire connection.

- **Split** the twin cable coming from the end of each arm and taking the marked core, bare the tail and twist, together with bared tail from the marked core from supply flex of centre tube. Twist the bared tails together and fix firmly, using the "Scruit" connector provided (110). N.B The live core is connected to the centre point of the screw type lamp holder.
- **Take** remaining unmarked wires and join to the unmarked supply wire from centre point, twisting together and making a final connection with the "Scruit" connector provided (110).
- **Fit** the metal cover (18) into position, concealing all electrical connections and secure with nut (19).
- **Place** bottom slip-on tube (21), Bowl (45), washer (22), and secure with nut (19) and finial (46) (hand tight only).

Before connecting ATTENTION must be exercised to the following: within the lighting fixture the neutral conductors **N** are marked with the below symbol, the phase conductors **L** are marked at the end with black colour.

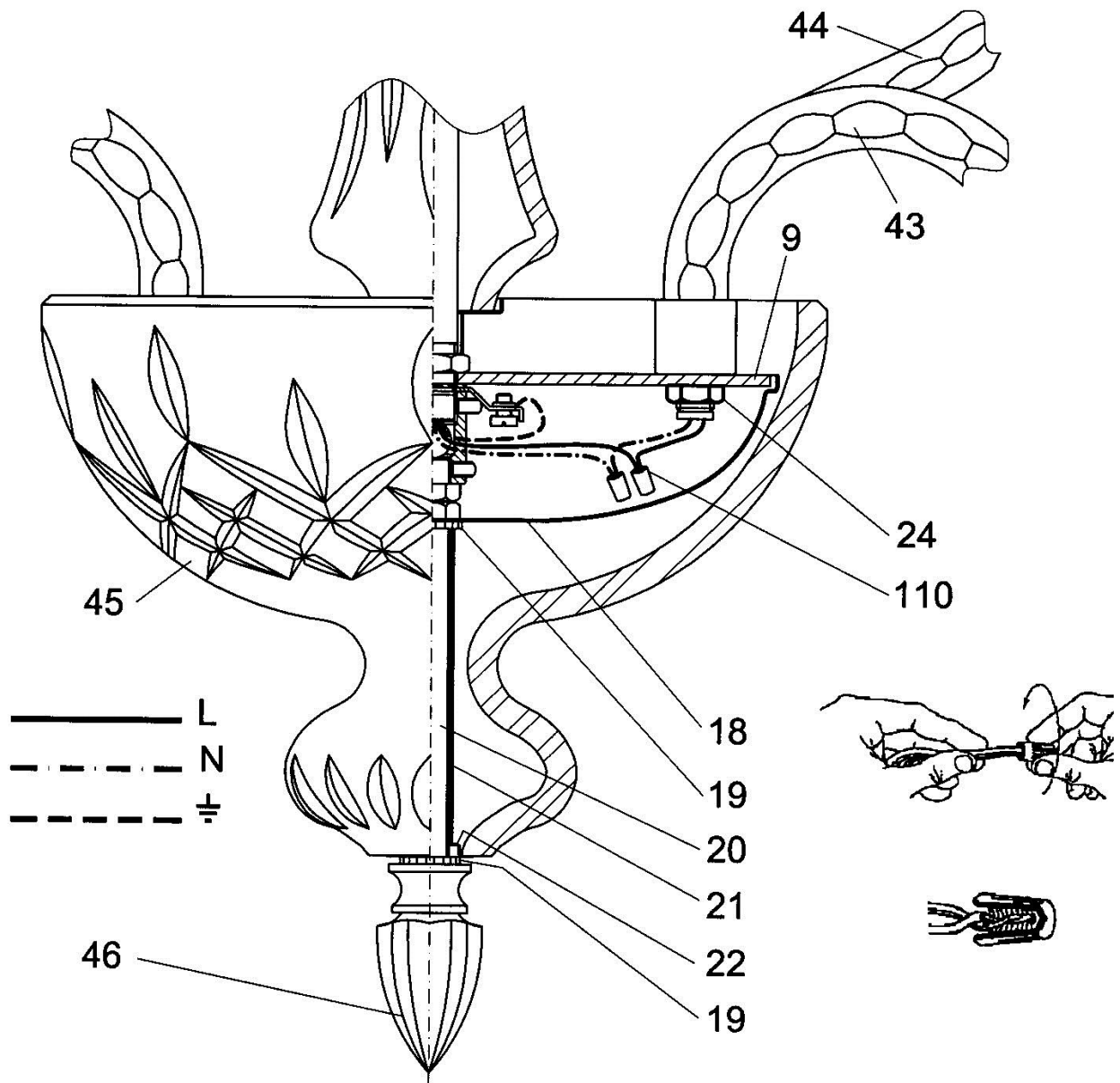

4.

Dressing the Chandelier

- **Attach** drops & buttons (trimming B) to holders (42) and place onto each arm.
- **Insert** lamps into lamp holders.
- **Attach** trimmings (A) & (C) to Crystal parts (40) & (44) as shown on below diagram

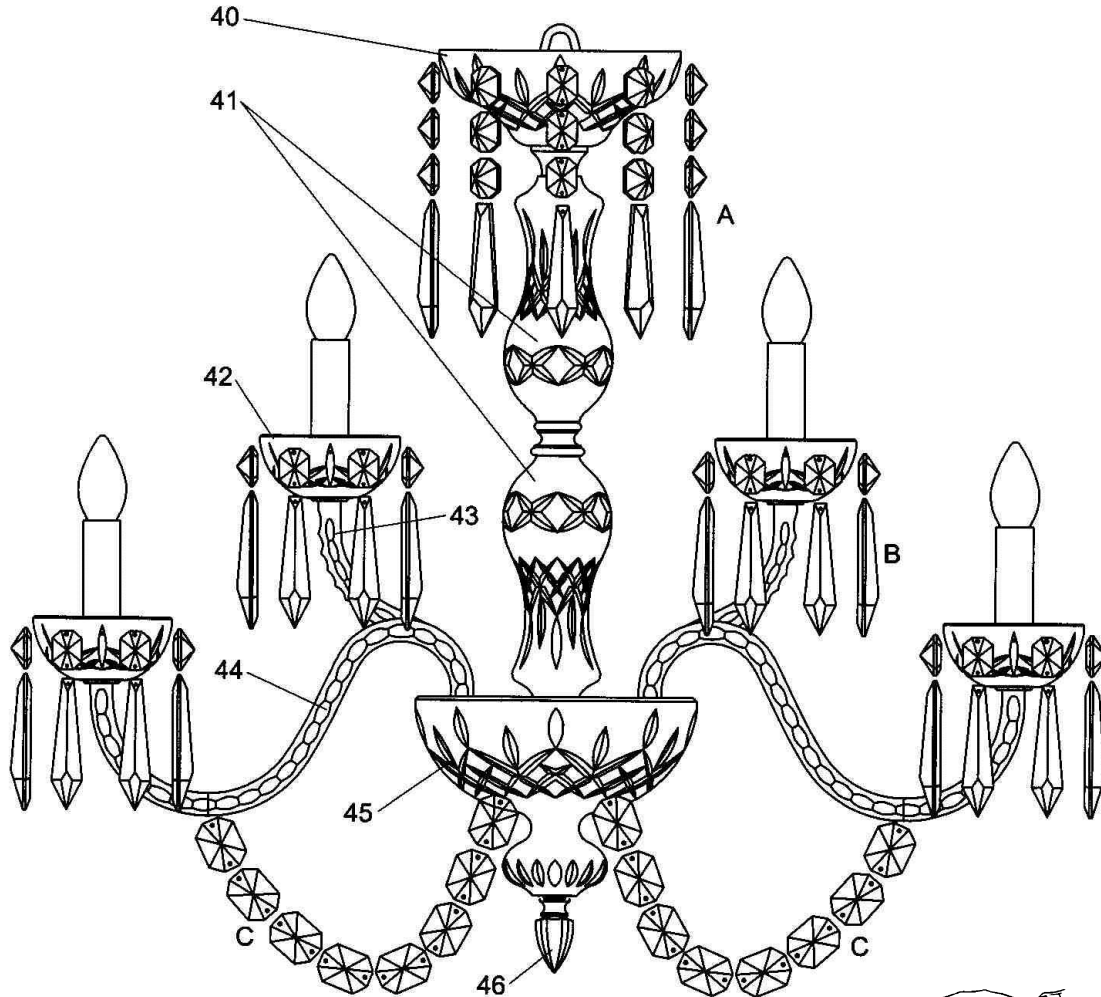









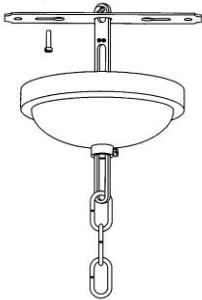
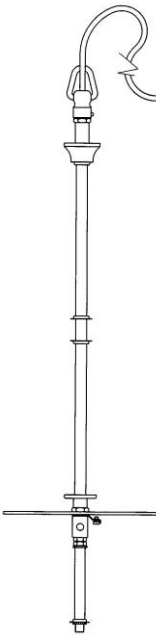

Height 690mm (27.5")
 Width 810mm (32")
 Weight 14kg (31lbs)

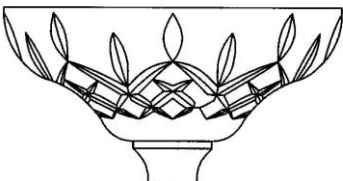
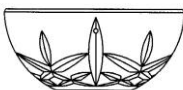
We recommend use of cloth gloves.

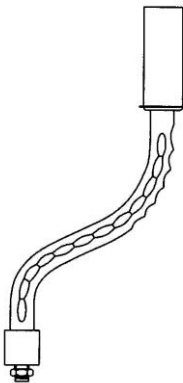
List of trimmings:

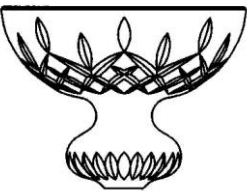
Trimming set	Contents	Number of pcs
A	059026 D6 Drop 3 inch + 3 x 059022 BU 2 button 22mm	8
B	059026 D6 Drop 3 inch + 059022 BU 2 button 22mm	54
C Chains of buttons	8 x 059024 BU 2 button 30mm	6

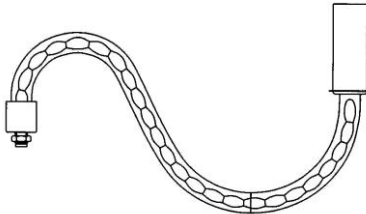
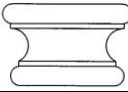
Contents List

<p>Suspension Set – (I) 1 pc</p> 	<p>Rod and plate assembly – (II) 1 pc</p> 	<p>Bulbs 40W/130V E12 – (621) 9 pcs</p> 
<p>B6 7" Lismore – 901 318 5800 – (40) 1 pc</p> 	<p>Holder – 119008 – (42) 9 pcs</p> 	<p>C20 Rod – 903 318 6700 – (41) 2 pcs</p> 
<p>Chandelier Arm – 900 599 6600 – (43) 3 pcs</p> 	<p>Carina 2,5" Finial – 037 190 5100 – (46) 1 pc</p> 	<p>Screw Connectors – (110) 6 pcs</p>  <p>Block connector (111) 1 pc</p> <p>B8 End Bowl – 901 318 6600 – (45) 1 pc</p> 
<p>Chain of Buttons – (C) 6 pcs</p> 	<p>A34 Arm – 900 318 6700 – (44) 6 pcs</p> 	<p>Chrome Spacer – (5) 1 pc</p>  <p>3" Drop and Buttons – (A) 8 pcs</p>  <p>3" Drop and Button – (B) 54 pcs</p> 

Technical specification:

<i>Dimensions</i>	Ø 690mm x 810mm (27.5in x 32in)
<i>Weight</i>	14kg (31 lbs)
<i>Surface treatment of metal</i>	Chromium
<i>Material of crystal parts</i>	Crystal
<i>Trimmings</i>	Traditional
<i>Electro Parameters</i>	9 x 40 W / 110 V AC
<i>Type of sockets</i>	9 x E12
<i>Bulbs</i>	9 x E12
<i>Kind of covering</i>	IP 20
<i>Class of protection</i>	I.

Recommendation for cleaning and maintenance:

- Do not cover the bulbs.
- Do not attempt to repair or replace components etc. – contact a professional service.
- Do not expose the light fitting to influences that could be harmful to it.
- Carry out cleaning and maintenance only if switched off.
- For cleaning of metallic parts apply a dry, soft duster only.
- For cleaning the crystal parts apply cleaning agents designed for crystal cleaning in the recommended concentration. Immediately after cleaning dry properly.
- Do not use dishwasher to clean crystal parts.

The Manufacturer retains the right to make small variances to the light fitting without notice.

This chandelier complies with, and has been tested in accordance with International Safety Standards. As the location and condition of the point of installation, including the point of anchorage and any other factors are completely outside the control of Waterford Crystal Ltd., the company cannot accept responsibility for any injury, loss or damage, (including consequential or special loss) howsoever caused, which may arise from the installation of this chandelier, the location and condition of the point of installation including the point of anchorage or the use of any fittings not supplied by the company in such installation. In all cases the maximum liability of the Company will not exceed the replacement cost of the chandelier



WATERFORD®

www.waterford.com

Waterford®, the Seahorse device
and featured product names are registered
trademarks. ©2009 WWRD Holdings Ltd.

No.	
------------	--