



CAL LIGHTING

3625 E. Philadelphia St. Ontario CA. 91761 • Tel: 909.947.5200 • Fax:
909.947.5673 • www.calighting.com • service@calighting.com •
Specifications subject to change without notice

Type: _____

Project: _____

Catalog No.: _____

Lamp/Wattage: _____

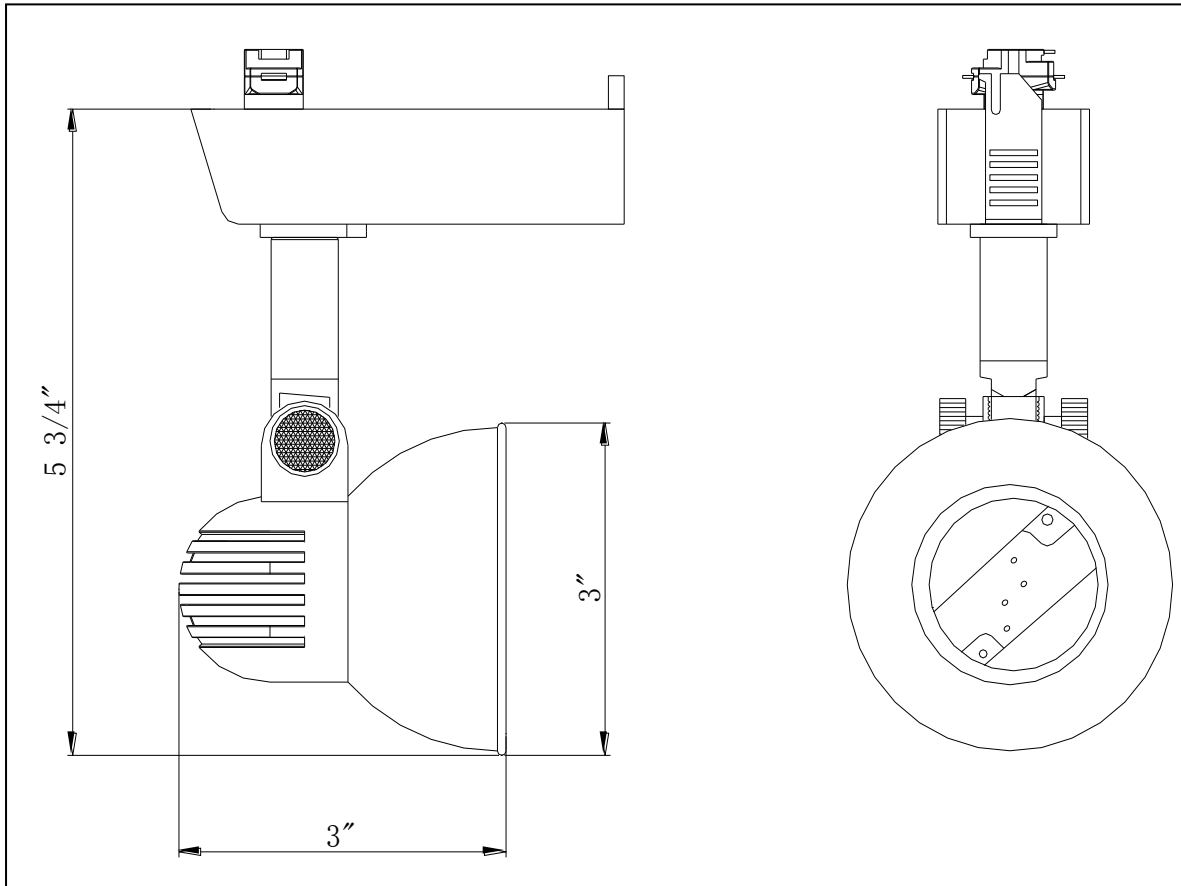

Model No. : HT-392

Rotation : 355 degree

Capability : ± 30 degree from horizontal

Bulb : MR16 (halogen)

Socket : G5.3

Voltage : 12V

Wattage : 50W Max.

Finish : DB (Dark Bronze)

Certificate : 