

CRYST RAMA



1958

95 Cantiague Rock Road, Westbury NY 11590
 ph:516.931.9090 fax: 516. 931.1254
 info@crystorama.com www.crystorama.com

MODEL#:4470 ASSEMBLY AND DRESSING INSTRUCTIONS



All electrical components must be installed by a licensed electrician in accordance with the National Electric Code and the appropriate local electrical codes.



You will have these parts & kits when you open the package.

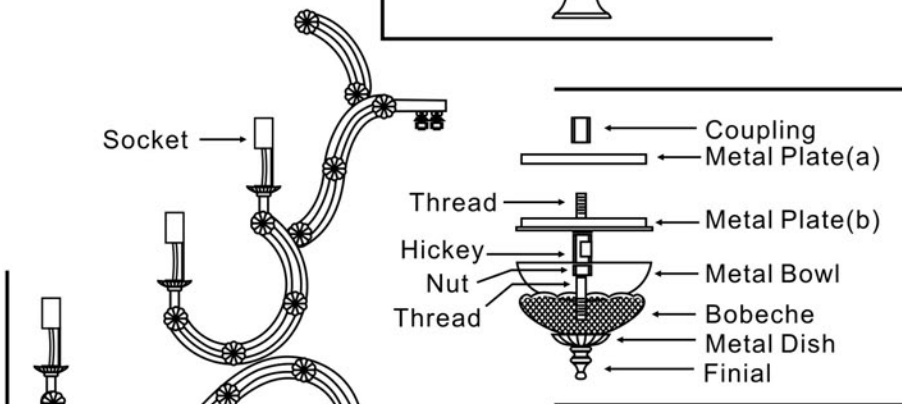
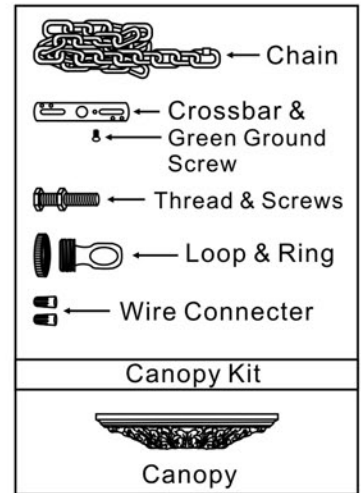
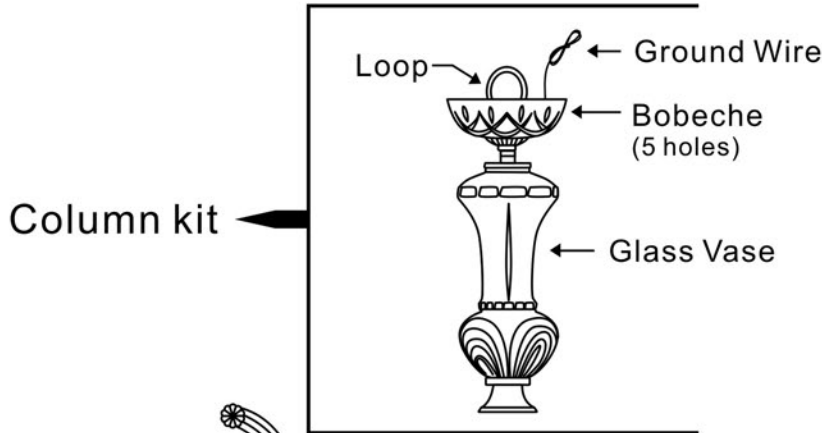

Center Kit

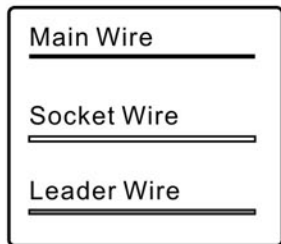
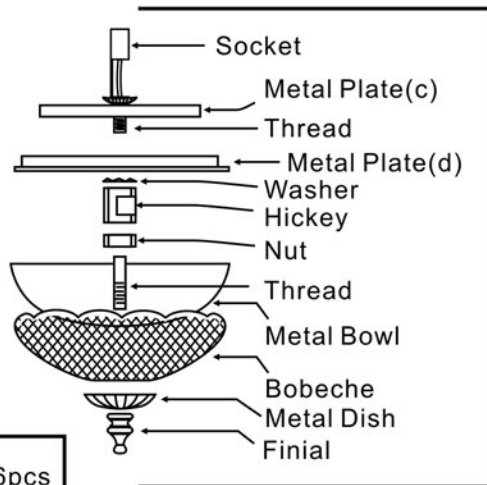

Bottom Kit

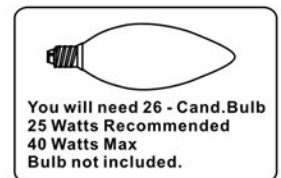
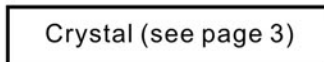
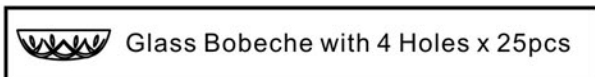
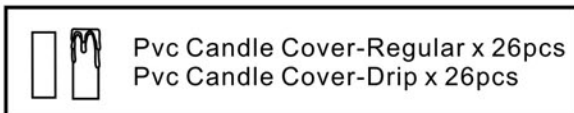

CRYST RAMA



1958

95 Cantiague Rock Road, Westbury NY 11590
 ph:516.931.9090 fax: 516. 931.1254
 info@crystorama.com www.crystorama.com



All electrical components must be installed by a licensed electrician in accordance with the National Electric Code and the appropriate local electrical codes.



MODEL#:4470 ASSEMBLY AND DRESSING INSTRUCTIONS

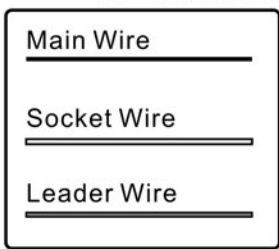
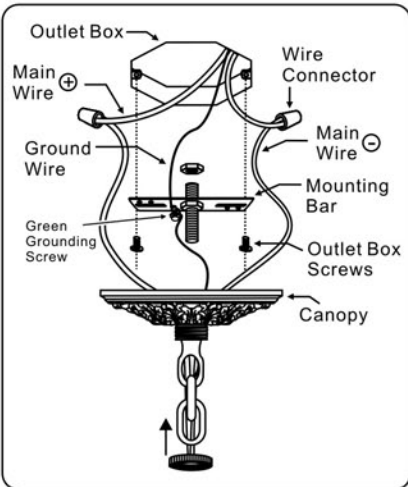

10) Dress the Chandelier with the crystals. (see page.3). End.

9) Put the Bobeche(4 holes) Candle Cover-Regular and Candle Cover-Drip in order on the socket.

2) Use the Wire Connector to connect the Main Wire, Lead Wire and Socket Wire(d).

7) Screw the Coupling on the Metal Plates(a).

5) Assemble the Hickey Nut Thread Metal bowl Center Bobeche and the Metal dish in order, and then screw the Finial well.

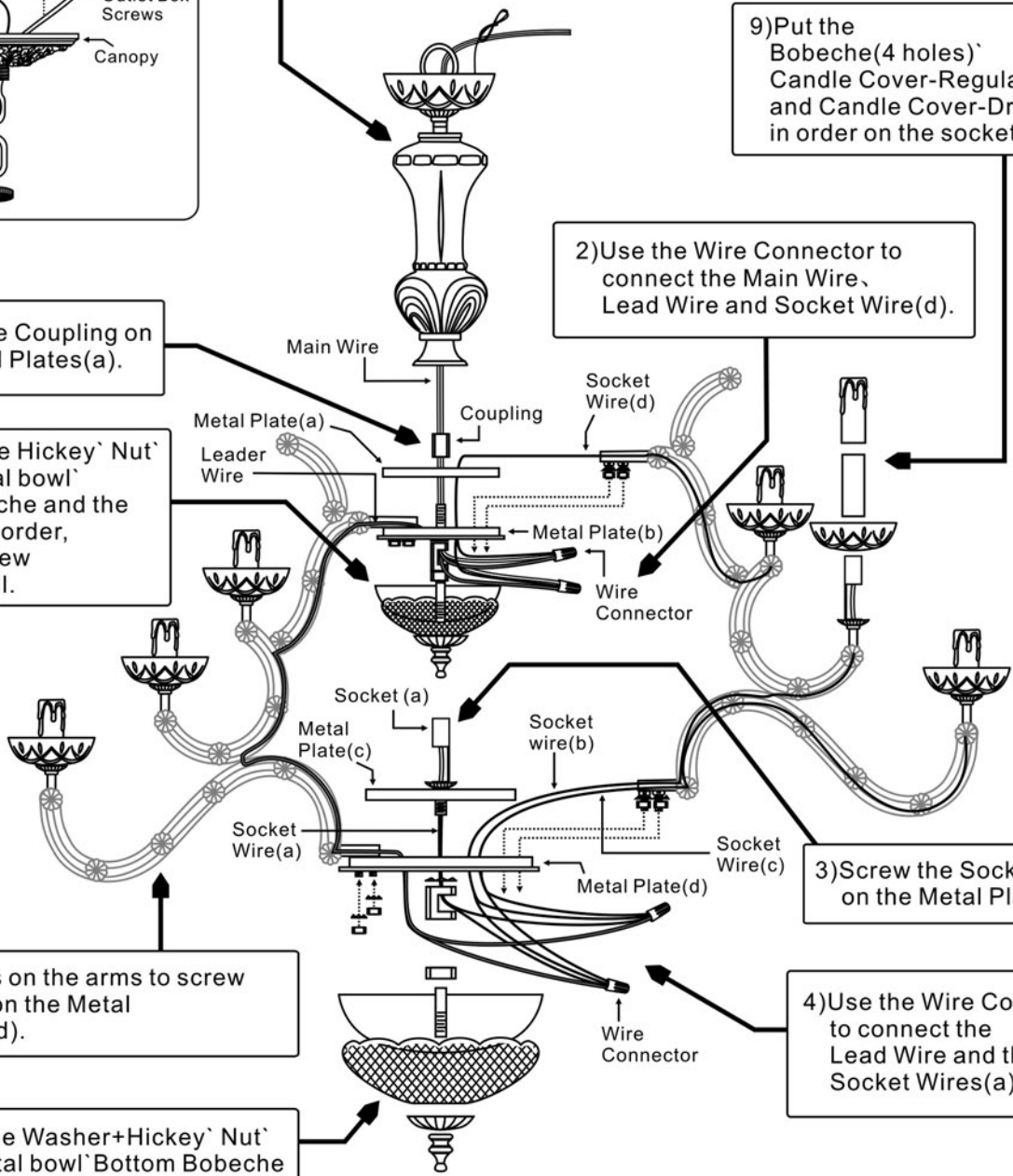

3) Screw the Socket(a) on the Metal Plate(d).

1) Use the Nuts on the arms to screw all the arms on the Metal Plates(b) & (d).

4) Use the Wire Connector to connect the Lead Wire and the Socket Wires(a) to (c).

6) Assemble the Washer+Hickey Nut Thread Metal bowl Bottom Bobeche and the Metal dish in order, and then screw the Finial well.

CRYST RAMA



1958

95 Cantiague Rock Road, Westbury NY 11590
 ph:516.931.9090 fax: 516. 931.1254
 info@crystorama.com www.crystorama.com



All electrical components must be installed by a licensed electrician in accordance with the National Electric Code and the appropriate local electrical codes.



MODEL#:4470 ASSEMBLY AND DRESSING INSTRUCTIONS

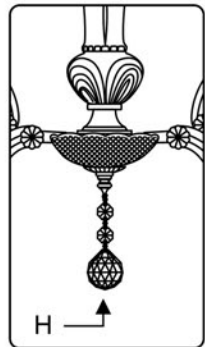
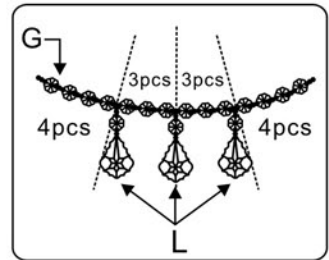
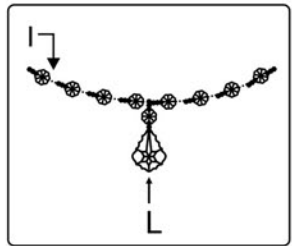
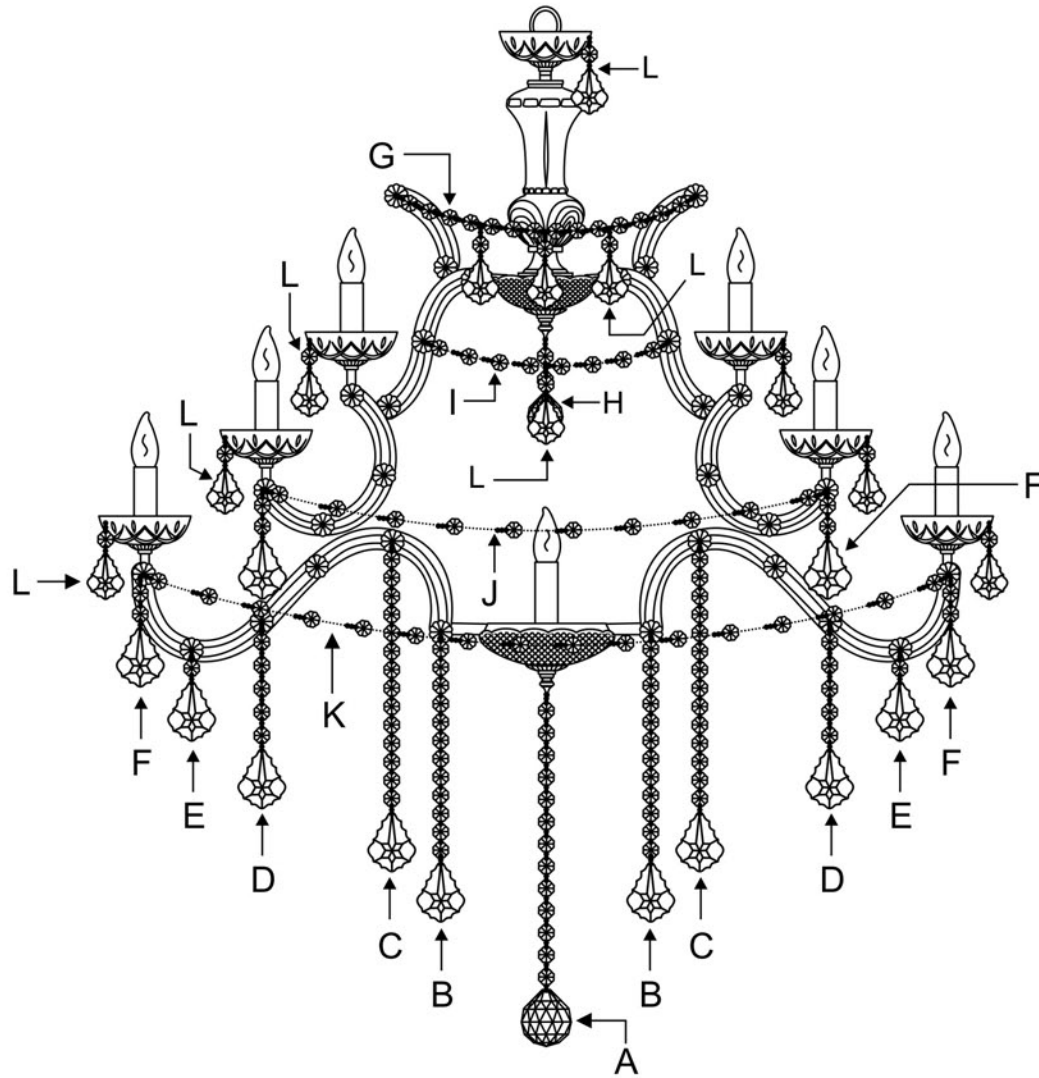

- A= (1x 50mm Ball+13 Jewels Strand)x1pc
- B= (12 Jewels Strand +20/75-3")x10sets
- C= (14 Jewels Strand +20/75-3")x10sets
- D= (5 Jewels Strand +20/75-3")x10sets
- E= (20/75-3")x10sets
- F= (2 Jewels+20/75-3")x20sets

- G= (14 Jewels Strand) x 5sets
- H= (1x 40mm Ball+2 Jewels) x1pc
- I= (8 Jewels Strand) x 5sets
- J= (10 Jewels Strand) x 10sets
- K= (16 Jewels Strand) x 10sets
- L= (20/64-2") x125sets

