

Item No. 1396

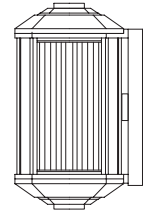

Drawing 1 - Fixture Mounting

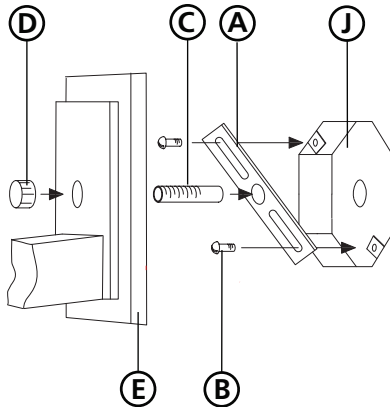

▼ start here

1

1. Find a clear area in which you can work.
2. Unpack fixture and glass from carton.
3. Carefully review instructions prior to assembly.

***** The construction of this fixture will be accomplished by first installing the mounting hardware to the junction box, making all necessary electrical connections, attaching the fixture to the wall and then installing the glass.**

2

1. Prior to mounting the fixture to the wall, it is necessary to remove the center glass.
2. To remove center glass, unthread top knob (1) - see **Drawing 2**.
3. Lift roof (2) off of fixture.
4. Remove thumb screws (3).
5. Remove roof support bracket (4).
6. Slip center ribbed glass (5) out of fixture cage (6).

Drawing 2 - Fixture Assembly

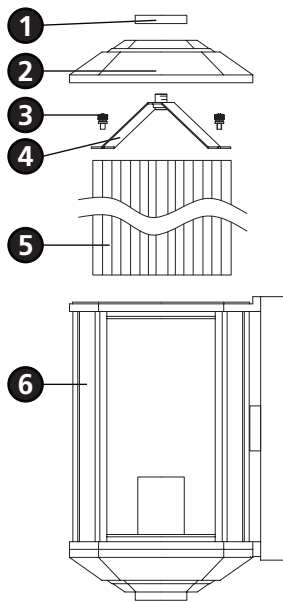

3

1. Prepare mounting strap (A) by threading 1" nipple (C) into the center hole of the mounting strap (A), approximately 1/4" - see **Drawing 1**.
2. Attach mounting strap (A) to junction box (J) using two screws (B) not provided.

SAFETY WARNING: READ WIRING AND GROUNDING INSTRUCTIONS (I.S. 18) AND ANY ADDITIONAL DIRECTIONS. TURN POWER SUPPLY OFF DURING INSTALLATION. IF NEW WIRING IS REQUIRED, CONSULT A QUALIFIED ELECTRICIAN OR LOCAL AUTHORITIES FOR CODE REQUIREMENTS.

4

Make electrical connections from supply wire to fixture lead wires. Refer to instruction sheet (I.S. 18) and follow all instructions to make all necessary wiring connections. Then refer back to this sheet to continue installation of this fixture.

5

1. To mount fixture, slip center hole of backplate (E) over nipple (C) and hold fixture in position - see **Drawing 1**.
2. Thread decorative knob (D) onto end of nipple (C) and tighten to secure fixture.
3. Fixture can now be lamped accordingly.
4. Replace center glass by following steps 2 through 6 in section 2 in reverse order.

Drawing 1 - Flush Mount



Drawing 2 - Chain Hung



Drawing 3 - Post-Mount



SAFETY WARNING: READ WIRING AND GROUNDING INSTRUCTIONS (I.S. 18) AND ANY ADDITIONAL DIRECTIONS. TURN POWER SUPPLY OFF DURING INSTALLATION. IF NEW WIRING IS REQUIRED, CONSULT A QUALIFIED ELECTRICIAN OR LOCAL AUTHORITIES FOR CODE REQUIREMENTS.

wiring instructions

Indoor Fixtures

1. Connect positive supply wire **(A)** (typically black or the smooth, unmarked side of the two-conductor cord) to positive fixture lead **(B)** with appropriately sized twist on connector - see **Drawings 1 or 2**.
2. Connect negative supply wire **(C)** (typically white or the ribbed, marked side of the two-conductor cord) to negative fixture lead **(D)**.
3. Please refer to the **grounding instructions** below to complete all electrical connections.

Outdoor Fixtures

1. Connect positive supply wire **(A)** (typically black or the smooth unmarked side of the two-conductor cord) to positive fixture lead **(B)** with appropriately sized twist on connector - see **Drawings 2 or 3**.
2. Connect negative supply wire **(C)** (typically white or the ribbed, marked side of the two-conductor cord) to negative fixture lead **(D)**.
3. Cover open end of connectors with silicone sealant to form a watertight seal.
 - If installing a wall mount fixture, use caulk to seal gaps between the fixture mounting plate (backplate) and the wall. This will help prevent water from entering the outlet box. If the wall surface is lap siding, use caulk and a fixture mounting platform specially.
4. Please refer to the **grounding instructions** below to complete all electrical connections.

grounding instructions

Flush Mount Fixtures

For positive grounding in a 3-wire electrical system, fasten the fixture ground wire **(E)** (typically copper or green plastic coated) to the fixture mounting strap **(1)** with the ground screw **(2)** - see **Drawing 1**.

Note: On straps for screw supported fixtures, first install the two mounting screws in strap. Any remaining tapped hole may be used for the ground screw.

Chain Hung Fixtures

Loop fixture ground wire **(E)** (typically copper or green plastic coated) under the head of the ground screw **(2)** on fixture mounting strap **(1)** and connect to the loose end of the fixture ground wire directly to the ground wire of the building system with appropriately sized twist-on connectors - see **Drawing 2**.

Post-Mount Fixtures

Connect fixture ground wire **(E)** (typically copper or green plastic coated) to power supply ground with appropriately sized twist-on connector inside post. Cover open end of connector with silicone sealant to form a watertight seal - see **Drawing 3**.

▼ start here

1. After securing fixture to the wall it is recommended that the gap between the wall and fixture backplate be sealed with any good quality waterproof caulk or silicone sealant. (NOT INCLUDED) See Drawing 1.

Drawing 1



1. After securing fixture in place it is recommended that the gap between the mounting top and fixture base be sealed with any good quality waterproof caulk or silicone sealant. (NOT INCLUDED). It is also recommended that a small bead of caulk or sealant be put under the ball knobs used to mount fixture. See Drawing 2.

Drawing 2

