



ALL • TOGETHER • BETTER

## USE AND CARE GUIDE

---

### ROUND MIRROR

(This mirror is suitable for use in the bathroom)

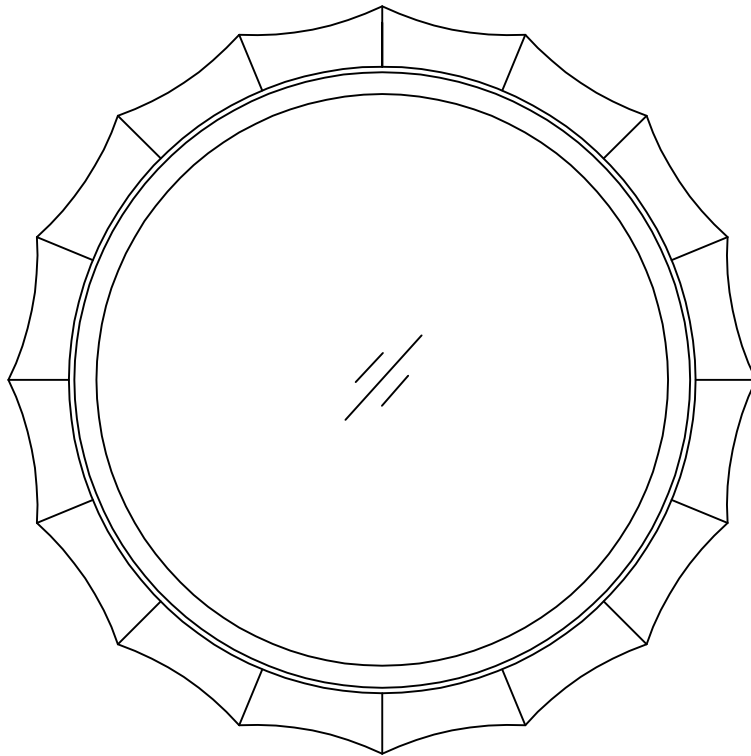

Above image represents many mirrors,  
your mirror may vary in style.

Questions, problems, missing parts? Before returning to the store,  
call Kenroy Home Customer Service  
8 a.m.-6 p.m., EST, Monday-Friday

**904-642-4340**

---

### ***THANK YOU***

We appreciate the trust and confidence you have placed in Kenroy Home through the purchase of this mirror.  
We strive to continually create quality products designed to enhance your home.  
Thank you for choosing us!

You should have received the following parts in the package.  
Please ensure that all parts are accounted for.

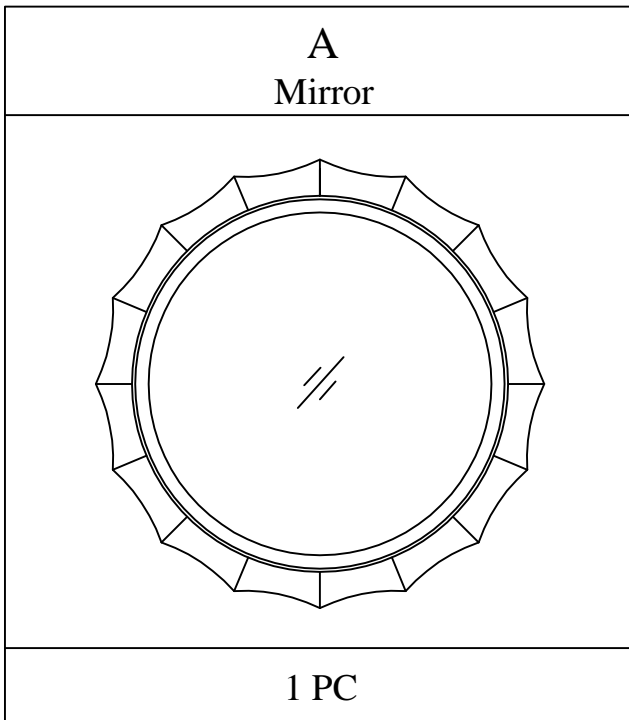

### SUGGESTED TOOLS (NOT SUPPLIED)

---

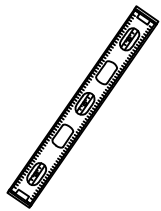

Level



Pencil

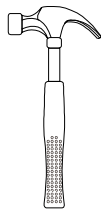

Hammer

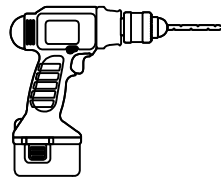

Drill

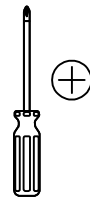

Phillips  
Screwdriver

NOTE: This mirror is suitable for use in the bathroom.

# Installation instructions

**1.** Measure the distance between the brackets, mark spots on the wall.

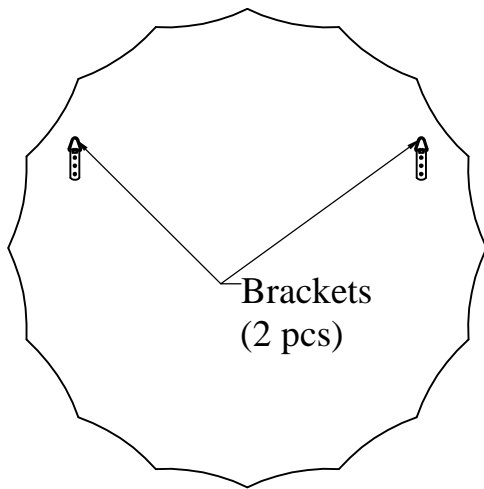

OR

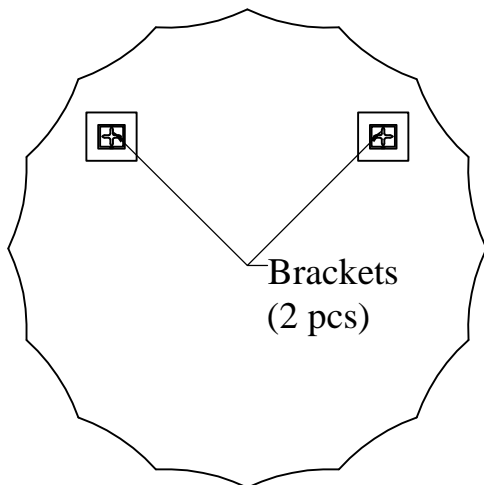

NOTE: Hardware not supplied, contact your local hardware professional to choose an attachment mechanism appropriate for your wall.

If installing to studs, please see below:

**2A.** Install (2) nails (not supplied) to the studs.

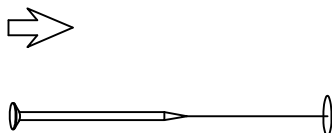

If installing to drywall, please see below:

**2B.** Drill pilot holes on the marked spots and insert (2) plastic anchors (not supplied).

**2C.** Install (2) wood screws (not supplied) to the (2) plastic anchors.

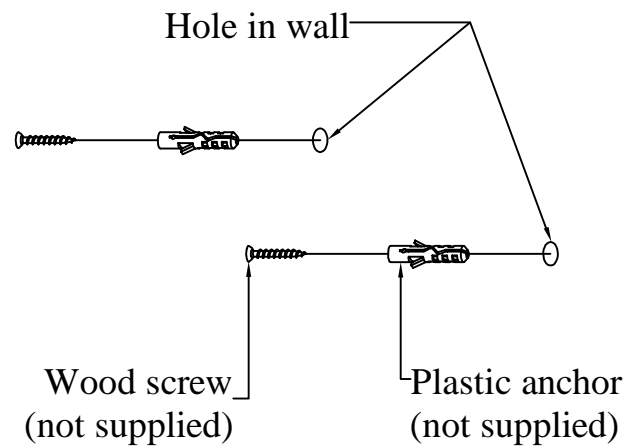

**3.** Hang mirror (A) to wall by attaching the brackets on back of the mirror to the nails or wood screws.

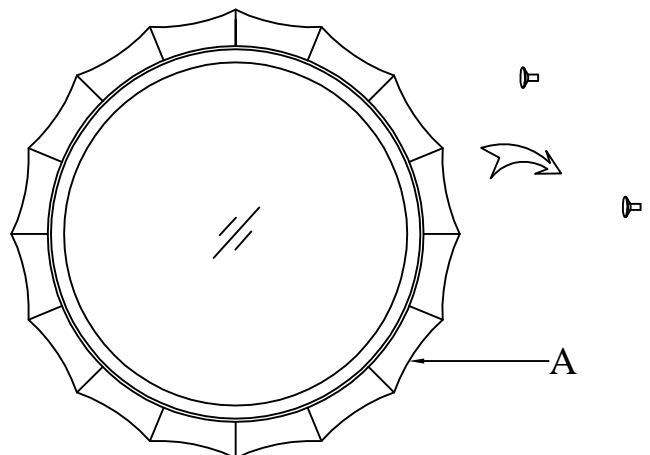



ALL • TOGETHER • BETTER



[www.kenroyhome.com](http://www.kenroyhome.com)

---

## CUSTOMER SUPPORT TEAM

For any additional questions or concerns please contact our Customer Support Team:

 **904-642-4340**

 **@KenroyHome**

 **[customerorders@kenroyhome.com](mailto:customerorders@kenroyhome.com)**