

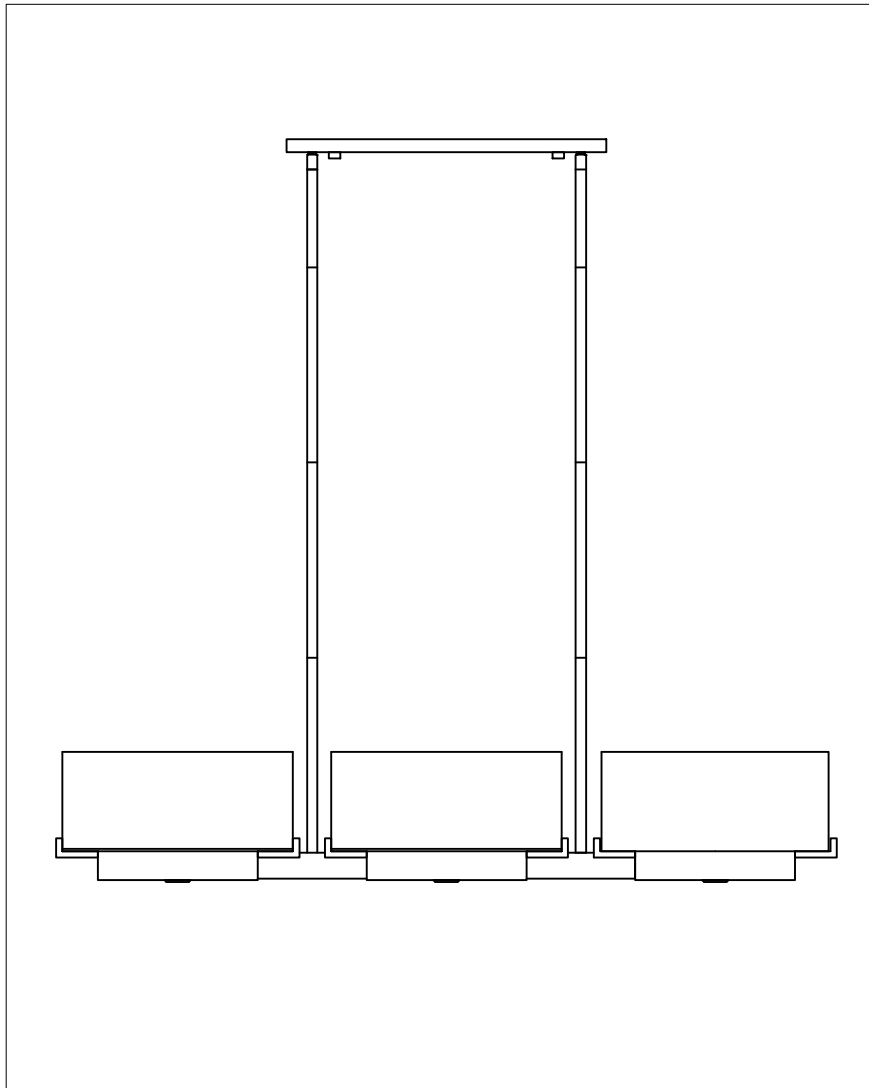

**PRODUCT NAME: Esquire**  
**ITEM NUMBER: 43664**

**Please consult your electrician for hanging fixture and wiring.**



**Bulb(included): 8 x GU24 LED 9W+4 x LED 2.5W**

**IMPORTANT: Turn off the power at the main fuse or circuit breaker box before starting installatio**

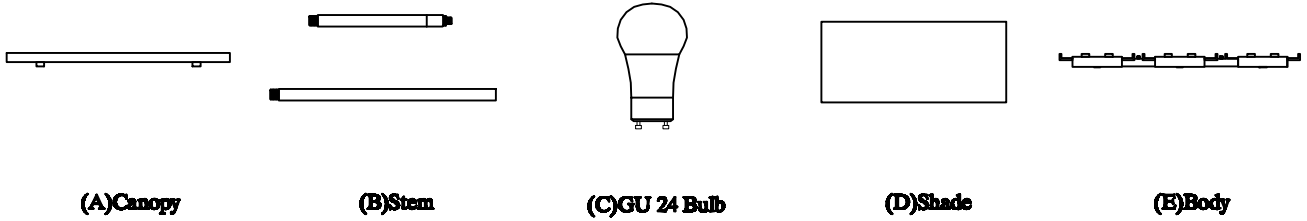

Locate all hardware & components before discarding packaging

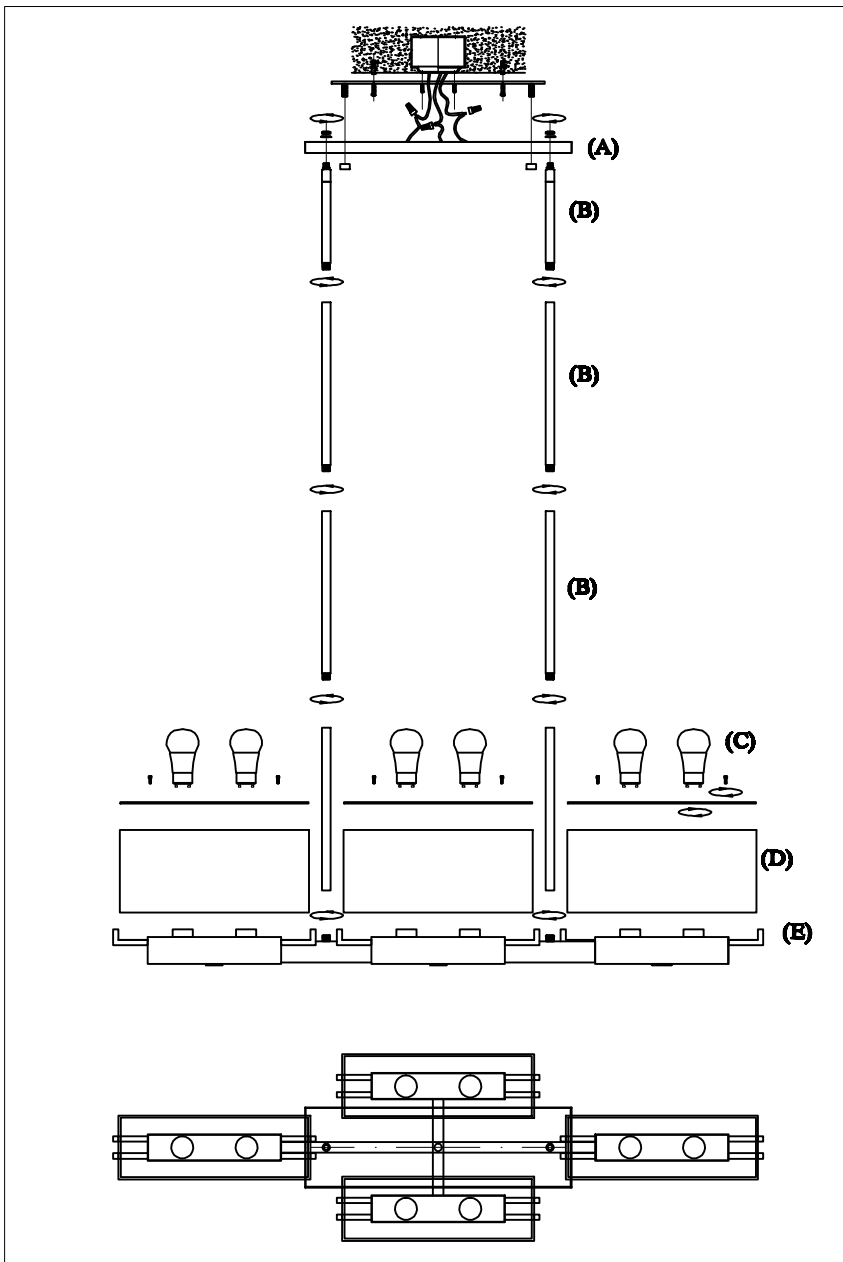

1.)

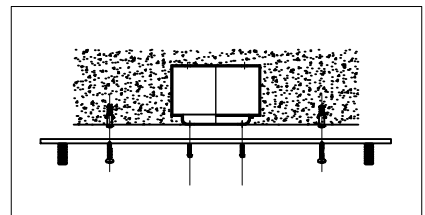

Step.1: Remove mounting bracket from fixture and install to electrical box

2.)

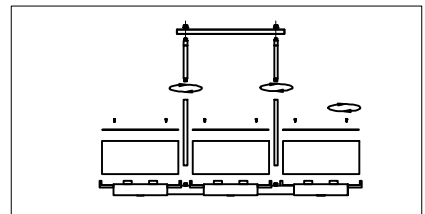

Step.2: Run wire through stems (B) and combine stem lengths to meet desired mounting height

3.)

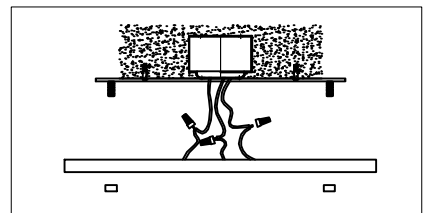

Step.3: Wire fixture to wires in outlet box. Copper/Green wire is for Ground. Install fixture to bracket and tighten screws at the ends of the canopy (A) to secure

4.)

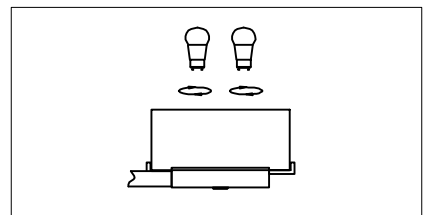

Step.4: Secure the lamp shade to the lamp body using the screw ring provided. Install the GU24 bulb.

**Cleaning & Care:**

Clean with soft cloth and a mild detergent. Do not use abrasive cleaner.