

Tools Required

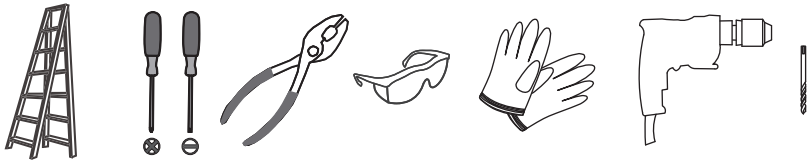



**⚠ Warnings and Cautions**

These instructions are provided for your safety. It is very important you read them completely before installing the mirror.

Quoizel recommends 2 people for each step during assembly.

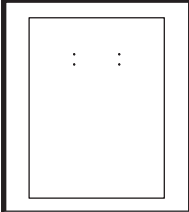
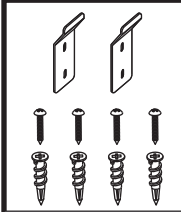
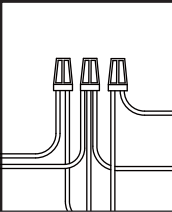
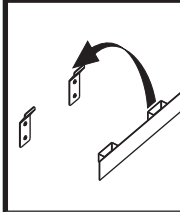
Table of Contents

<p>Mirror Template</p>  <p>STEP 1</p>	<p>Wall Anchors, Screws &amp; Hangers</p>  <p>STEP 2</p>	<p>Wiring</p>  <p>STEP 3</p>	<p>Install Mirror</p>  <p>STEP 4</p>	<p>Clean</p>  <p>STEP 5</p>
--	---	---	--	--

STEP 1

**Note: Mirror Shapes may varies according to purchased.**  
Temporarily attach the mirror template on the wall in the desired mirror hanging location.

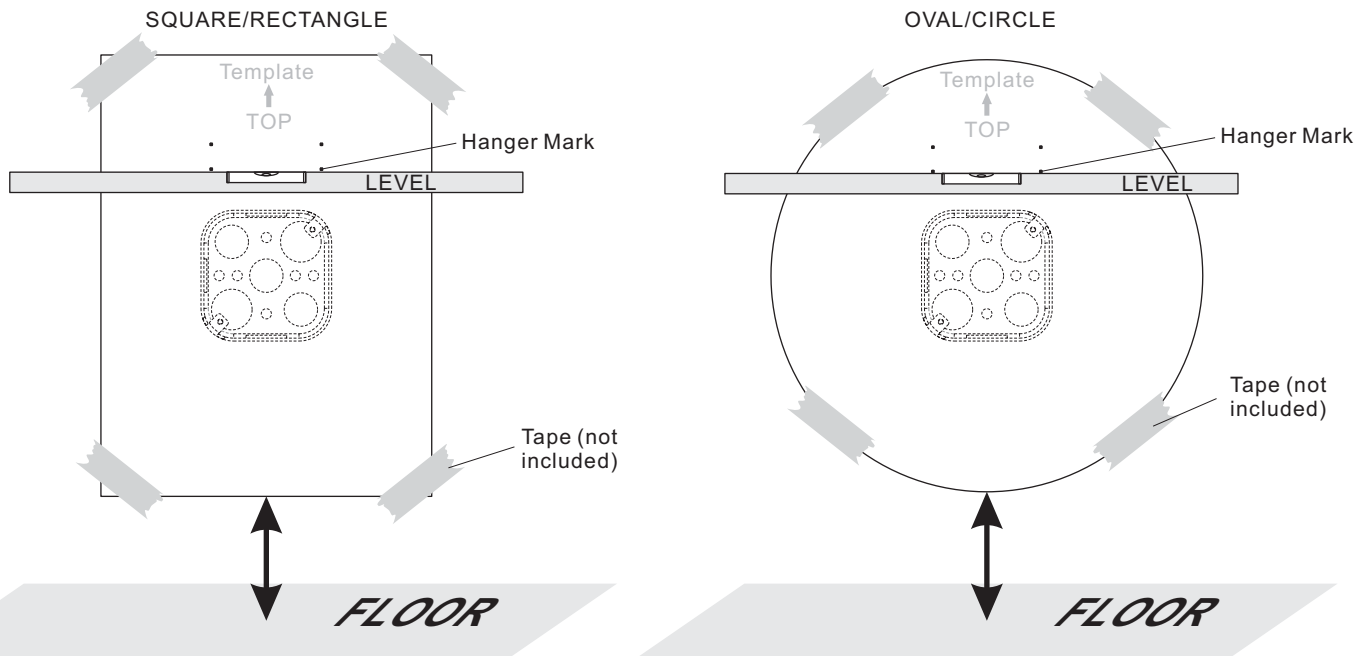

## STEP 2

1

Poke and Mark Points  
on the Wall

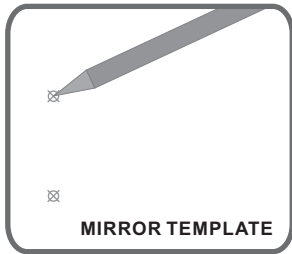

Remove  
Mirror Template

2

Drill Hole

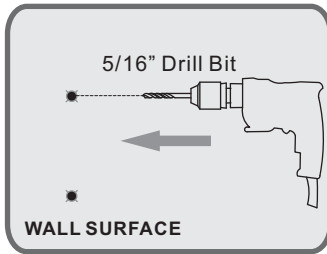

3

Insert Wall Anchor

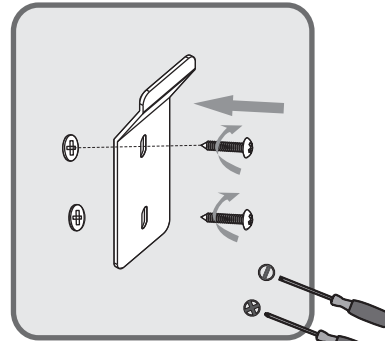
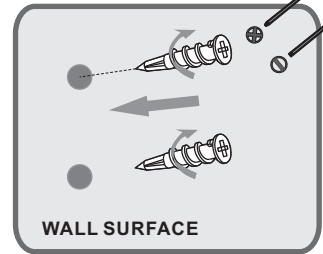

4

## STEP 3

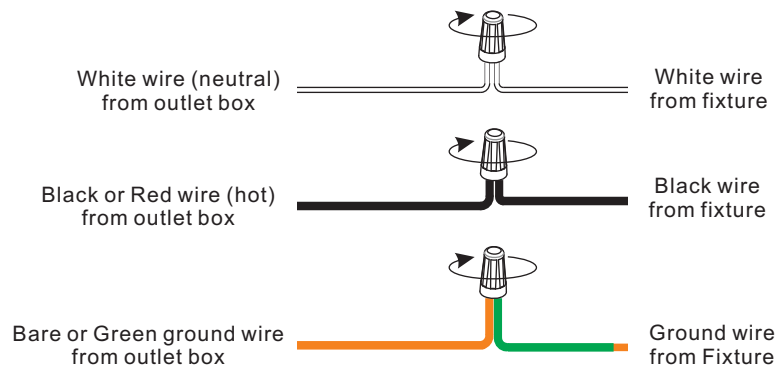

## STEP 4

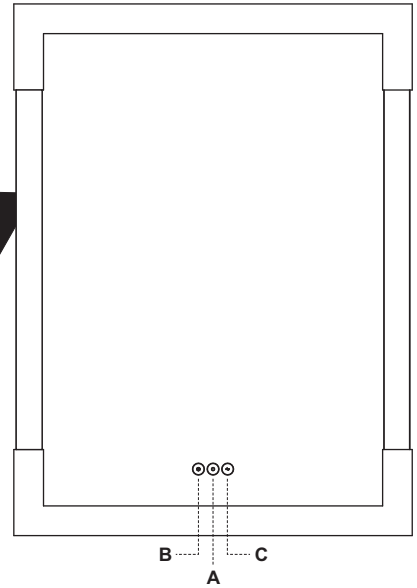
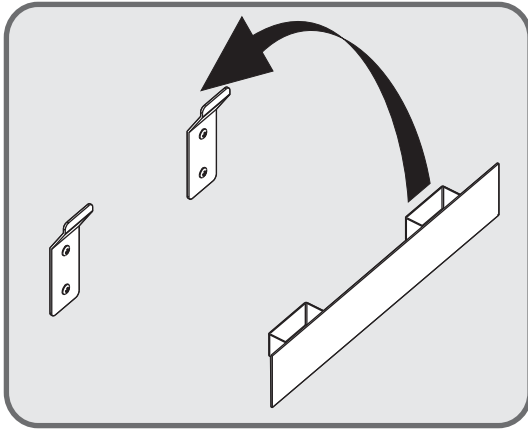

Button A: On/Off switch  
Button B: Dimmer switch  
Button C: Color Temperature switch

## STEP 5

1

Remove Protective Film

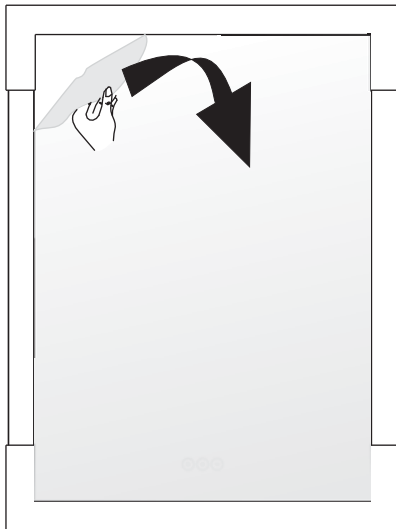

2

Clean Mirror

