

Please go to [www.quirrel.com](http://www.quirrel.com) for product cleaning tips. Go to the **Care + Maintenance** selection.

**Tools Required:** Flathead screwdriver, Phillips screwdriver, pliers, wire cutters, wire strippers, electrical tape, safety glasses.

**Light Source:** (7) A19 Medium Base Bulbs 60W Maximum, Medium Base T9 Vintage Bulbs are recommended, bulbs not included.

**Fixture Hanging Height:** Minimum Hanging Height is 15.75", Maximum Hanging Height is 105.75".

**Estimated Assembly Time:** 30-45 minutes

**Preparation:** Identify and inspect all parts before beginning installation. Check package content list and diagrams below to be sure all parts are present. If any parts are missing or damaged, do not attempt to assemble, install, or operate the fixture. Missing Parts? Contact your original place of purchase.

### ⚠ Warnings and Cautions

Turn off electricity at circuit breaker or main fuse box before installation. Consult a licensed electrician if in doubt.

These instructions are provided for your safety. It is very important you read them completely before installing the fixture. We strongly recommend that a licensed, professional electrician perform the installation.

Disconnect fixture from power source before replacing bulbs. Make sure bulbs are given sufficient time to cool before removal.

### Package Contents

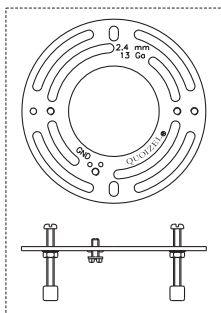

**A** Crossbar Assembly  
x 1

**B** Wire Connectors  
x 6

**C** Safety Clip  
x 7

**D** Small Ring  
x 1

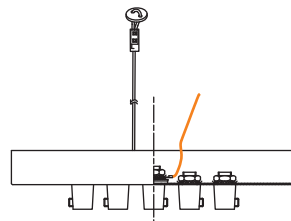

**E** Ceiling Canopy  
x 1

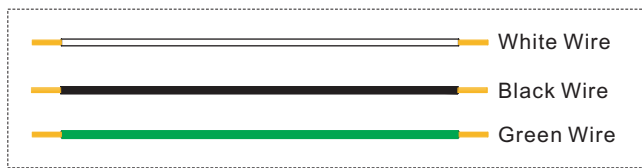

**F** Jumper Wires  
x 2

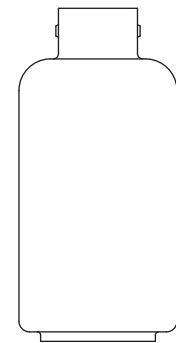

**G** Shade  
x 7

**H** Lock Rod  
x 21

**I** Fixture Body  
x 7

### STEP 1 - Installing the Crossbar Assembly

A. Pass the supply wires from outlet box through the Crossbar Assembly (A). Attach the Crossbar Assembly (A) to the Outlet Box with the head of the Green Ground Screw facing you. Secure the Crossbar Assembly (A) with Outlet Box Screws (not included). Tighten until snug.

Figure 1

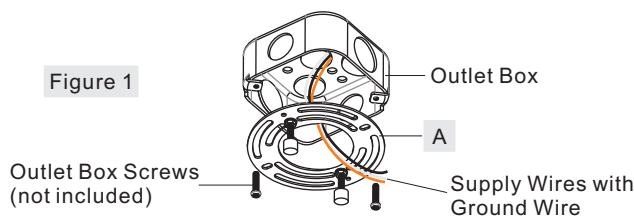

### (Step 2 Continued)

achieved. Once the Ceiling Canopy (E) is secure, remove the mounting ball and Ceiling Canopy (E) and proceed to Step 3.

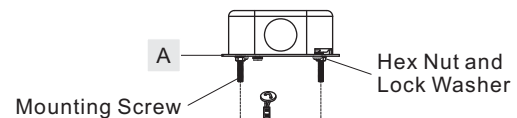

Figure 2

### STEP 2 - Test Fitting Ceiling Canopy to Crossbar Assembly

A. Remove mounting balls from the Crossbar Assembly (A). Fit the Ceiling Canopy (E) to the Crossbar Assembly (A) and secure with mounting balls. Note: The Ceiling Canopy (E) should be snug against the ceiling and the mounting balls. If not, adjust the length of the nipple on the Crossbar Assembly (A) by unscrewing the preassembled hex nut and lock washer and then screwing the mounting screws in or out of the crossbar until the correct length is

**Please measure the height you want to hang the pendant prior to hanging so you know what length to cut the wire. You can add 6" to that length to help adjust the shades up or down once it's hung. Please note, all the extra wire will not fit inside the small canopy and junction box, the wire needs to be cut at the desired length to fit inside the canopy and junction box to then help adjust to the exact height. IMPORTANT: Install the cord into the ceiling canopy before cutting it to length.**

### STEP 3 - Install Fixture Bodies to Ceiling Canopy

- Loosen set screws located on the couplings that are mounted to the underside of the Ceiling Canopy (E). Do not remove set screws completely.
- Thread pendant cord through Small Ring (D) before threading cord through the coupling mounted to the underside of the Ceiling Canopy (E). Adjust cord to the desired length then tighten set screw to hold pendant length in place.
- Install Safety Clips (C) onto the pendant cords by threading the cord through one hole then back through the second. Slide Safety Clips (C) to approximate 2" from canopy.
- Repeat these steps for all pendants.
- After the ceiling canopy is installed to the junction box, a final adjustment can be made to get the pendants to hang at the desired height by loosening the set screws on the coupling slightly then re-tighten when the pendants are adjusted to the desired height.

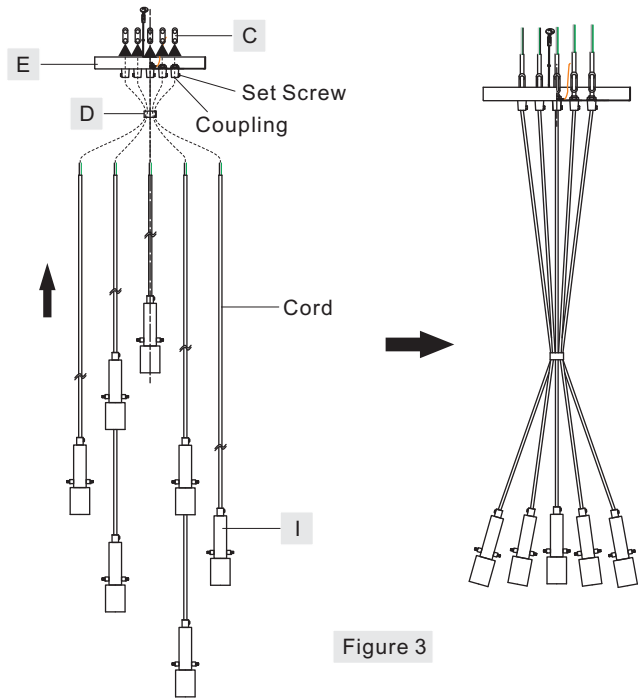
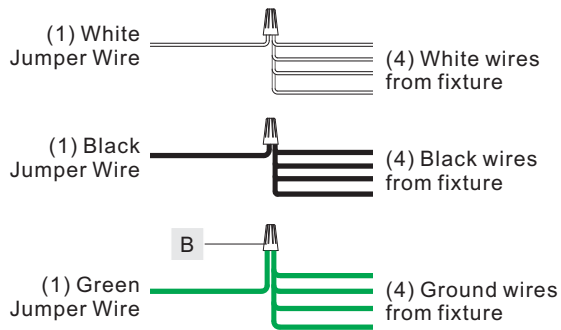

Figure 3

### STEP 4 - Connections Fixture Wires to Jumper Wires

- Strip back the clear wire covering on the 3 pendant cords to expose the black, white and green wire. Leave at least approximately 3" of cord length inside of the ceiling canopy. Strip each end of 3 fixture wires.
- Use supplied wire connectors (B) to connect fixture wires to Jumper Wires (F). Twist connectors until wires are tightly joined together. Wrap each connection with approved electrical tape.
- There are two sets up jumpers that have to be wired to the pendant wires. The first set of jumpers will use the wires from 4 pendants. The second set of jumpers will use the remaining wires from 3 pendants. Follow the illustrations below for correct wiring.



#### WIRING FOR 4 SETS OF WIRES

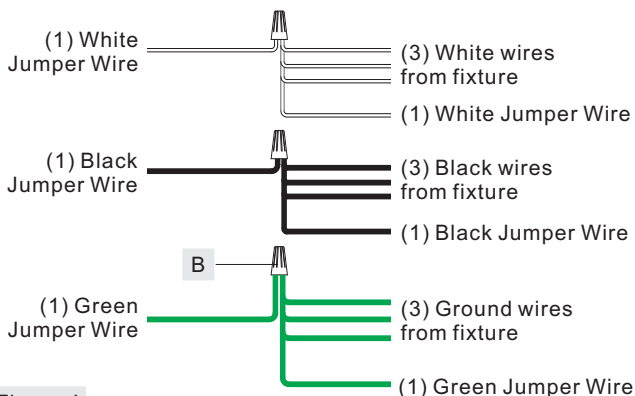

Figure 4

#### WIRING FOR 3 SETS OF WIRES

### STEP 5 - Attach the Lanyard

- The purpose of the lanyard is to provide a means to support the fixture hands free from the junction box while connecting the electrical wires.
- Turn the Button Stop so it may be inserted into a Crossbar slot. Make sure the Button Stop is completely inside the Crossbar. Slowly release the fixture to make sure it is supported by the Button Stop. Proceed to the wiring steps in the next step. Once you are complete with the wiring, the Lanyard will push into the junction box when the fixture is placed for final mounting.

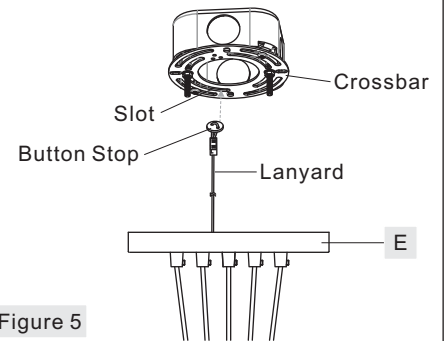

Figure 5

### STEP 6 - Wire Connections

- Wrap bare or green ground wire around green ground screw on the crossbar, no less than 2 inches from the end of the wire. Tighten the green ground screw.
- Use standard wire connectors (not included) to make all wire connections. Twist connectors until wires are tightly joined together. Wrap each connection with approved electrical tape and carefully stuff all the connected wires into the Outlet Box.

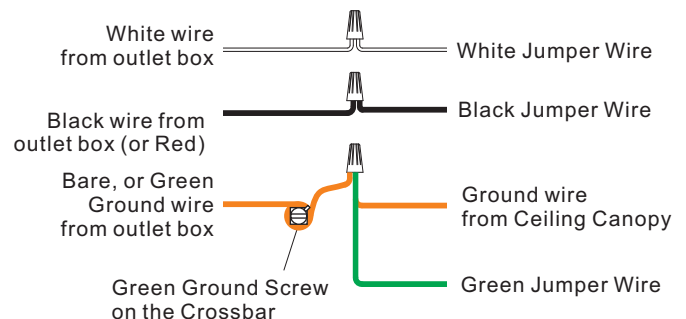

Figure 6

**STEP 7 - Install Ceiling Canopy**

A. Carefully tuck all wires into the outlet box and position the Ceiling Canopy (E) over the outlet box. Align the holes in the ceiling canopy with the mounting screws, then attach the Ceiling Canopy (E) using the previously removed mounting balls. Hand tighten until snug.

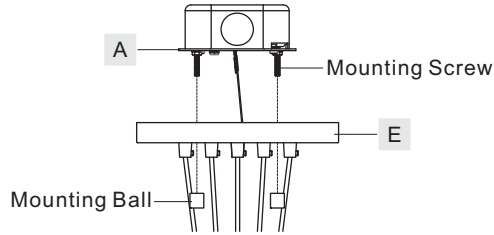

Figure 7

**STEP 8 - Install Shades and Bulbs**

A. Place the Shade (G) over the socket and align holes on the side of the Shade (G) to bolts on the side of the Fixture Body (I). Place Lock Rods (H) through holes on the side of the Shade (G) and thread them onto bolts. Hand tighten until snug.  
 B. Insert bulbs onto sockets and screw snugly into place.

Your fixture is now assembled and ready to use. Enjoy!

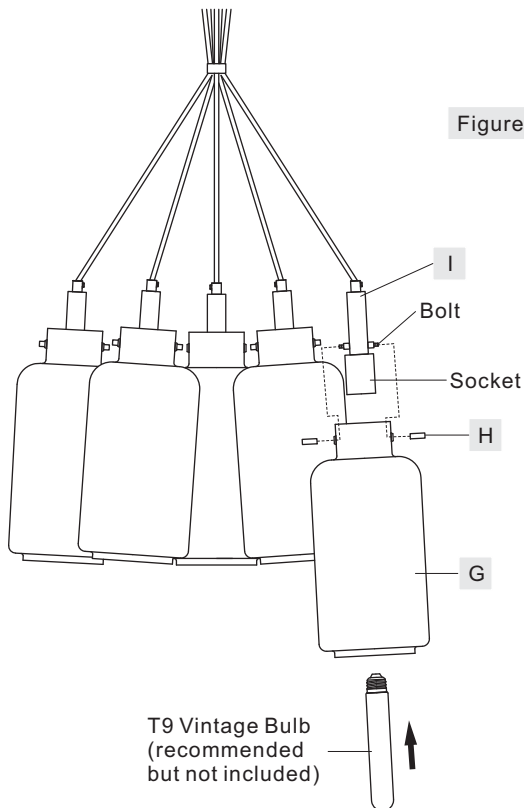
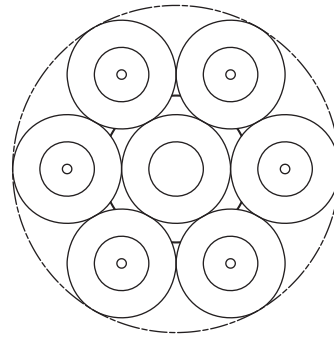
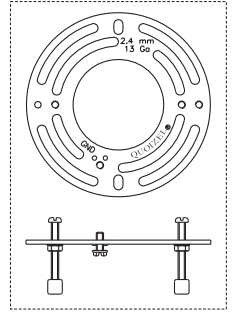

Figure 8

TGA2607EK

FINISH: EARTH BLACK



**BOTTOM VIEW**

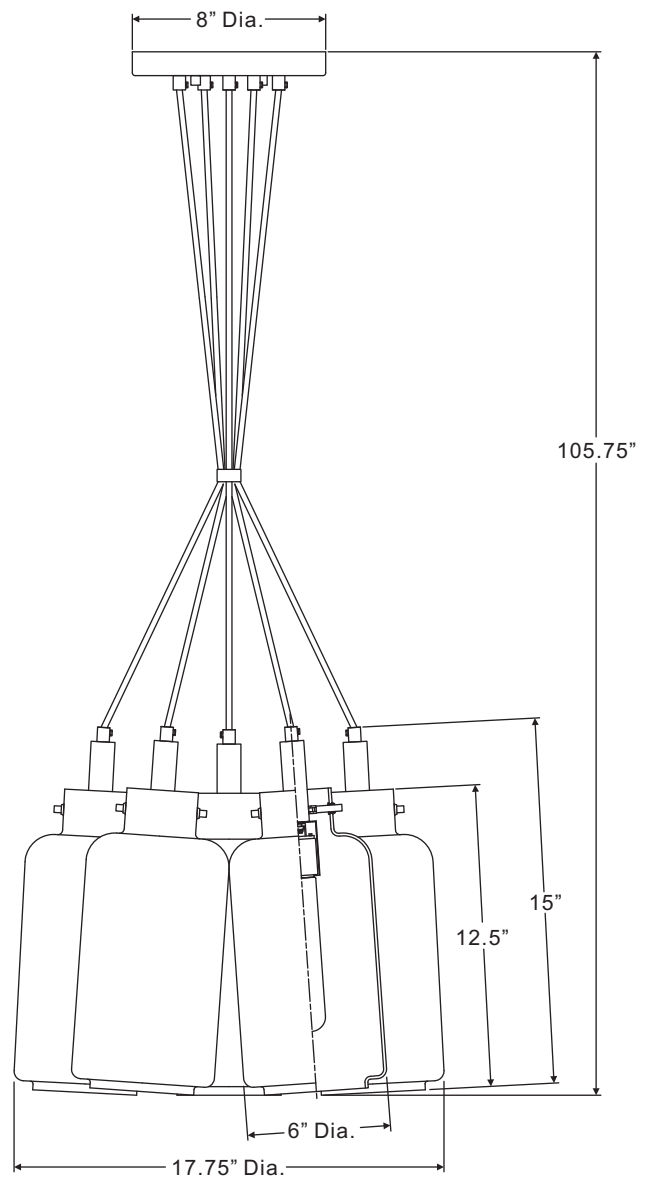

NOTE: ALL DIMENSIONS ARE ROUNDED UP TO THE NEAREST 1/4"