

Fixture Type: \_\_\_\_\_

Catalog Number: \_\_\_\_\_

Project: \_\_\_\_\_

Location: \_\_\_\_\_

## Tesla Pro 3.5" Open Reflector Trim Round

Model	Beam	Color Temp & CRI	Lumens	CBCP	Finish
HR3LEDT118P	F 55°	827 2700K - 80	1130	1389	BBN Black/Brushed Nickel
		830 3000K - 80	1174	1436	BCB Black/Copper Bronze
		835 3500K - 80	1280	1580	BN Brushed Nickel
		840 4000K - 80	1335	1634	BWT Black/White
		927 2700K - 90	935	1161	CB Copper Bronze
		930 3000K - 90	1100	1386	HBN Haze/Brushed Nickel
	N 30°	827 2700K - 80	1165	1386	HCB Haze/Copper Bronze
		830 3000K - 80	1195	2536	HWT Haze/White
		835 3500K - 80	1325	2907	WT White
		840 4000K - 80	1365	3011	
		927 2700K - 90	970	2130	
		930 3000K - 90	1110	2438	
	S 15°	827 2700K - 80	925	4267	
		830 3000K - 80	990	4573	
		835 3500K - 80	1005	4269	
		840 4000K - 80	1030	4747	
		927 2700K - 90	775	3585	
		930 3000K - 90	705	3245	

Example: **HR3LEDT118PF827BBN**

### DESCRIPTION

Tesla series is at the pinnacle of where lighting innovation meets energy-efficiency. A high-performance serviceable integrated LED with a state of the art light engine delivers incredible maintenance-free optics and performance ideal for high-end residential and commercial applications. With a wide variety of solid die-cast trims in a multitude of handsome plated or powder coated finishes, the Tesla collection is sure to enhance style and appeal in any space. Tesla PRO provides up to 60% higher lumen output over the standard Tesla collection for when more lighting is required such as in tall ceiling applications. The trim and LED engine are manufactured as a single unit with endless amounts of specifications including shape and finish of trim, adjustability, color temperature, and beam distribution to create the perfect combinations of form, factor, and function.

### FEATURES

- 30° visual cutoff angle for glare control
- 5 year warranty

### SPECIFICATIONS

<b>Construction:</b>	Die-cast aluminum construction
<b>Power:</b>	22W
<b>Input:</b>	120-277 VAC, 50/60Hz
<b>Dimming:</b>	ELV: 100-5%, 0-10V: 100-0%
<b>Light Source:</b>	Integrated LED
	3 Step Mac Adam Ellipse
<b>Rated Life:</b>	50000 Hours
<b>Mounting:</b>	Heavy gauge retention clips support trim firmly
<b>Finish:</b>	Enamel coated Black/White, Electroplated Brushed Nickel, Electroplated Black/Copper Bronze, Electroplated Black/Brushed Nickel, Electrostatically Powder Coated White, Enamel Coated Haze/White, Enamel Coated Haze/Copper Bronze, Enamel Coated Haze/Brushed Nickel, Electroplated Copper Bronze
<b>Ceiling Thickness:</b>	1/2" - 3/4"
<b>Operating Temp:</b>	-4°F to 104°F (-20°C to 40°C)
<b>Standards:</b>	ETL, cETL, Damp Location Listed



### FINISHES

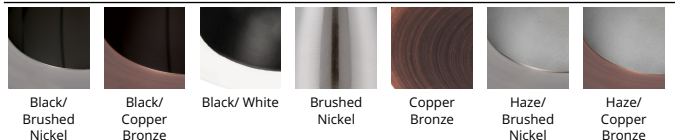

### LINE DRAWING

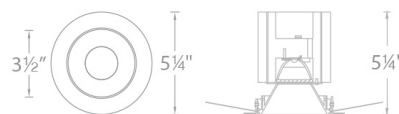

Fixture Type: \_\_\_\_\_

Catalog Number: \_\_\_\_\_

Project: \_\_\_\_\_

Location: \_\_\_\_\_

## Tesla 3.5"

### New Construction Housing Airtight

#### Model & Product

HR-3LED-H22D-A Tesla 3.5in LED Non-IC New Construction Housing

Example: **HR-3LED-H22D-A**

#### DESCRIPTION

Tesla series is at the pinnacle of where lighting innovation meets energy-efficiency. A high-performance serviceable integrated LED with a state of the art light engine delivers incredible maintenance-free optics and performance ideal for high-end residential and commercial applications. With a wide variety of solid die-cast trims in a multitude of handsome plated or powder coated finishes, the Tesla collection is sure to enhance style and appeal in any space. Tesla PRO provides up to 60% higher lumen output over the standard Tesla collection for when more lighting is required such as in tall ceiling applications. The trim and LED engine are manufactured as a single unit with endless amounts of specifications including shape and finish of trim, adjustability, color temperature, and beam distribution to create the perfect combinations of form, factor, and function.

#### FEATURES

- Tesla 3.5in LED Non-IC New Construction Housing
- The Tesla series is engineered with state of the art high output LED technology for optimal thermal management and heat dissipation
- Driver concealed within the fixture
- 5 year warranty

#### SPECIFICATIONS

<b>Construction:</b>	20 Gauge cold rolled steel
<b>Power:</b>	22.5W
<b>Input:</b>	120-277 VAC, 50/60Hz
<b>Dimming:</b>	ELV: 100-5%, 0-10V: 100-0%
<b>Mounting:</b>	Heavy gauge retention clips secures housing firmly to ceiling
<b>Cut Out:</b>	4 5/8"
<b>Finish:</b>	
<b>Ceiling Thickness:</b>	1/2" - 3/4"
<b>Operating Temp:</b>	-4°F to 104°F (-20°C to 40°C)
<b>Standards:</b>	ETL, cETL, Non IC, Airtight



#### LINE DRAWING

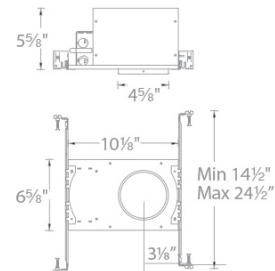

## Tesla 3.5"

### New Construction Housing IC Airtight

#### Model & Product

HR-3LED-H15D-ICA Tesla 3.5in LED IC Rated New Construction Housing

Example: **HR-3LED-H15D-ICA**

#### DESCRIPTION

Tesla series is at the pinnacle of where lighting innovation meets energy-efficiency. A high-performance serviceable integrated LED with a state of the art light engine delivers incredible maintenance-free optics and performance ideal for high-end residential and commercial applications. With a wide variety of solid die-cast trims in a multitude of handsome plated or powder coated finishes, the Tesla collection is sure to enhance style and appeal in any space. Tesla PRO provides up to 60% higher lumen output over the standard Tesla collection for when more lighting is required such as in tall ceiling applications. The trim and LED engine are manufactured as a single unit with endless amounts of specifications including shape and finish of trim, adjustability, color temperature, and beam distribution to create the perfect combinations of form, factor, and function.

#### FEATURES

- Tesla 3.5in LED IC Rated New Construction Housing
- The Tesla series is engineered with state of the art high output LED technology for optimal thermal management and heat dissipation
- Driver concealed within the fixture
- 5 year warranty

#### SPECIFICATIONS

<b>Construction:</b>	20 Gauge cold rolled steel
<b>Power:</b>	14.5W
<b>Input:</b>	120-277 VAC, 50/60Hz
<b>Dimming:</b>	ELV: 100-5%, 0-10V: 100-0%
<b>Mounting:</b>	Heavy gauge retention clips support trim firmly
<b>Cut Out:</b>	4 5/8"
<b>Finish:</b>	
<b>Ceiling Thickness:</b>	1/2" - 3/4"
<b>Operating Temp:</b>	-4°F to 104°F (-20°C to 40°C)
<b>Standards:</b>	ETL, cETL, IC, Airtight

Fixture Type: \_\_\_\_\_

Catalog Number: \_\_\_\_\_

Project: \_\_\_\_\_

Location: \_\_\_\_\_

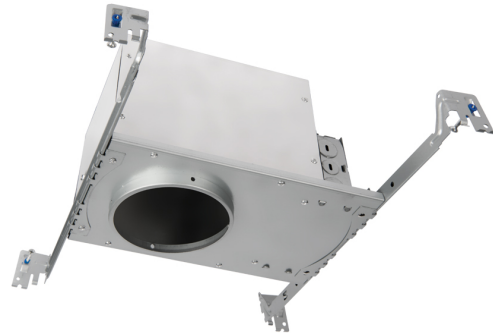

#### LINE DRAWING

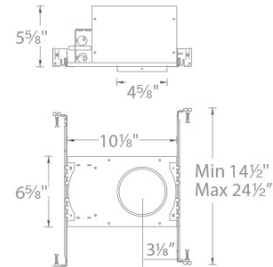

Fixture Type: \_\_\_\_\_

Catalog Number: \_\_\_\_\_

Project: \_\_\_\_\_

Location: \_\_\_\_\_

## Tesla 3.5"

### New Construction Housing IC Airtight

#### Model & Product

HR3LED-H18D1 Tesla 3.5in LED IC-Rated Airtight Narrow New Construction Housing

Example: **HR-3LED-H18D1-ICA**

#### DESCRIPTION

Tesla series is at the pinnacle of where lighting innovation meets energy-efficiency. A high-performance serviceable integrated LED with a state of the art light engine delivers incredible maintenance-free optics and performance ideal for high-end residential and commercial applications. With a wide variety of solid die-cast trims in a multitude of handsome plated or powder coated finishes, the Tesla collection is sure to enhance style and appeal in any space. Tesla PRO provides up to 60% higher lumen output over the standard Tesla collection for when more lighting is required such as in tall ceiling applications. The trim and LED engine are manufactured as a single unit with endless amounts of specifications including shape and finish of trim, adjustability, color temperature, and beam distribution to create the perfect combinations of form, factor, and function.

#### FEATURES

- Tesla 3.5in LED IC-Rated Airtight Narrow New Construction Housing
- The Tesla series is engineered with state of the art high output LED technology for optimal thermal management and heat dissipation
- Driver concealed within the fixture
- 5 year warranty

#### SPECIFICATIONS

<b>Construction:</b>	20 Gauge cold rolled steel
<b>Power:</b>	21.5W
<b>Input:</b>	120-277 VAC, 50/60Hz
<b>Dimming:</b>	ELV: 100-5%, 0-10V: 100-0%
<b>Mounting:</b>	Heavy gauge retention clips secures housing firmly to ceiling
<b>Cut Out:</b>	4 5/8"
<b>Finish:</b>	
<b>Ceiling Thickness:</b>	1/2" - 3/4"
<b>Operating Temp:</b>	-4°F to 104°F (-20°C to 40°C)
<b>Standards:</b>	ETL, cETL, IC, Airtight



#### LINE DRAWING

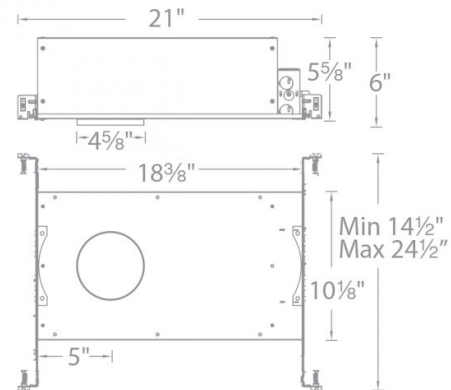

Fixture Type: \_\_\_\_\_

Catalog Number: \_\_\_\_\_

Project: \_\_\_\_\_

Location: \_\_\_\_\_

## Tesla 3.5" Remodel Housing

### Model & Product

HR-3LED-R22D Tesla 3.5in LED Non-IC Remodel Housing for Adjustable Trim

Example: **HR-3LED-R22D**

### DESCRIPTION

Tesla series is at the pinnacle of where lighting innovation meets energy-efficiency. A high-performance serviceable integrated LED with a state of the art light engine delivers incredible maintenance-free optics and performance ideal for high-end residential and commercial applications. With a wide variety of solid die-cast trims in a multitude of handsome plated or powder coated finishes, the Tesla collection is sure to enhance style and appeal in any space. Tesla PRO provides up to 60% higher lumen output over the standard Tesla collection for when more lighting is required such as in tall ceiling applications. The trim and LED engine are manufactured as a single unit with endless amounts of specifications including shape and finish of trim, adjustability, color temperature, and beam distribution to create the perfect combinations of form, factor, and function.

### FEATURES

- Tesla 3.5in LED Non-IC Remodel Housing for Adjustable Trim
- The Tesla series is engineered with state of the art high output LED technology for optimal thermal management and heat dissipation
- Driver concealed within the fixture
- 5 year warranty

### SPECIFICATIONS

<b>Construction:</b>	20 Gauge cold rolled steel
<b>Power:</b>	21.5W
<b>Input:</b>	120-277 VAC, 50/60Hz
<b>Dimming:</b>	ELV: 100-5%, 0-10V: 100-0%
<b>Mounting:</b>	Heavy gauge retention clips secures housing firmly to ceiling
<b>Cut Out:</b>	4 5/8"
<b>Finish:</b>	
<b>Ceiling Thickness:</b>	1/2" - 1"
<b>Operating Temp:</b>	-4°F to 104°F (-20°C to 40°C)
<b>Standards:</b>	ETL, cETL, Non IC



### LINE DRAWING

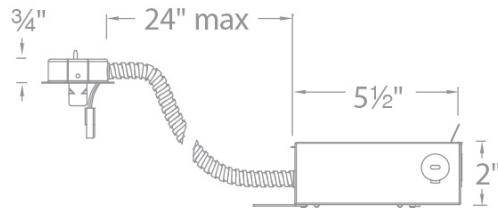

# WAC LIGHTING

Fixture Type: \_\_\_\_\_

Catalog Number: \_\_\_\_\_

Project: \_\_\_\_\_

Location: \_\_\_\_\_

## Tesla 3.5"

### Remodel Housing Airtight

#### Model & Product

HR-3LED-R18D-A Tesla 3.5in LED Non-IC Remodel Housing

Example: **HR-3LED-R18D-A**

#### DESCRIPTION

Tesla series is at the pinnacle of where lighting innovation meets energy-efficiency. A high-performance serviceable integrated LED with a state of the art light engine delivers incredible maintenance-free optics and performance ideal for high-end residential and commercial applications. With a wide variety of solid die-cast trims in a multitude of handsome plated or powder coated finishes, the Tesla collection is sure to enhance style and appeal in any space. Tesla PRO provides up to 60% higher lumen output over the standard Tesla collection for when more lighting is required such as in tall ceiling applications. The trim and LED engine are manufactured as a single unit with endless amounts of specifications including shape and finish of trim, adjustability, color temperature, and beam distribution to create the perfect combinations of form, factor, and function.

#### FEATURES

- Tesla 3.5in LED Non-IC Remodel Housing
- The Tesla series is engineered with state of the art high output LED technology for optimal thermal management and heat dissipation
- Driver concealed within the fixture
- 5 year warranty

#### SPECIFICATIONS

Construction:	20 Gauge cold rolled steel
Power:	21.5W
Input:	120-277 VAC, 50/60Hz
Dimming:	ELV: 100-5%, 0-10V: 100-0%
Mounting:	Heavy gauge retention clips secures housing firmly to ceiling
Cut Out:	4 5/8"
Finish:	
Ceiling Thickness:	1/2" - 3/4"
Operating Temp:	-4°F to 104°F (-20°C to 40°C)
Standards:	ETL, cETL, Non IC, Airtight



#### LINE DRAWING

