

Fixture Type: _____

Catalog Number: _____

Project: _____

Location: _____

Tesla Pro 3.5" Open Reflector Trim Square

Model	Beam	Color Temp & CRI	Lumens	CBCP	Finish
HR3LED718P	F 52°	827 2700K - 80	1155	1451	BN Brushed Nickel
		830 3000K - 80	1215	1525	CB Copper Bronze
		835 3500K - 80	1310	1654	WT White
		840 4000K - 80	1355	1731	
		927 2700K - 90	990	1258	
		930 3000K - 90	1100	1397	
	N 30°	827 2700K - 80	1190	2570	
		830 3000K - 80	1235	2650	
		835 3500K - 80	1350	2923	
		840 4000K - 80	1385	2972	
		927 2700K - 90	1005	2183	
		930 3000K - 90	1130	2248	
	S 15°	827 2700K - 80	920	4307	
		830 3000K - 80	985	4615	
		835 3500K - 80	1000	4669	
		840 4000K - 80	1025	4792	
		927 2700K - 90	775	3618	
		930 3000K - 90	700	3275	

Example: **HR3LED718PF827BN**

DESCRIPTION

Tesla series is at the pinnacle of where lighting innovation meets energy-efficiency. A high-performance serviceable integrated LED with a state of the art light engine delivers incredible maintenance-free optics and performance ideal for high-end residential and commercial applications. With a wide variety of solid die-cast trims in a multitude of handsome plated or powder coated finishes, the Tesla collection is sure to enhance style and appeal in any space. Tesla PRO provides up to 60% higher lumen output over the standard Tesla collection for when more lighting is required such as in tall ceiling applications. The trim and LED engine are manufactured as a single unit with endless amounts of specifications including shape and finish of trim, adjustability, color temperature, and beam distribution to create the perfect combinations of form, factor, and function.

FEATURES

- 30° visual cutoff angle for glare control
- 5 year warranty

SPECIFICATIONS

Construction:	Die-cast aluminum construction
Power:	22W
Input:	120-277 VAC, 50/60Hz
Dimming:	ELV: 100-5%, 0-10V: 100-0%
Light Source:	Integrated LED 3 Step Mac Adam Ellipse
Rated Life:	50000 Hours
Mounting:	Heavy gauge retention clips support trim firmly
Finish:	Electrostatically Powder Coated White, Electroplated Brushed Nickel, Electroplated Copper Bronze
Ceiling Thickness:	1/2" - 3/4"
Operating Temp:	-4°F to 104°F (-20°C to 40°C)
Standards:	ETL, cETL, Damp Location Listed



FINISHES

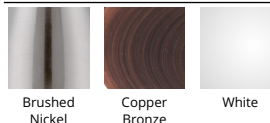

LINE DRAWING

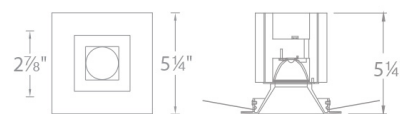

Fixture Type: _____

Catalog Number: _____

Project: _____

Location: _____

Tesla 3.5"

New Construction Housing Airtight

Model & Product

HR-3LED-H22D-A Tesla 3.5in LED Non-IC New Construction Housing

Example: **HR-3LED-H22D-A**

DESCRIPTION

Tesla series is at the pinnacle of where lighting innovation meets energy-efficiency. A high-performance serviceable integrated LED with a state of the art light engine delivers incredible maintenance-free optics and performance ideal for high-end residential and commercial applications. With a wide variety of solid die-cast trims in a multitude of handsome plated or powder coated finishes, the Tesla collection is sure to enhance style and appeal in any space. Tesla PRO provides up to 60% higher lumen output over the standard Tesla collection for when more lighting is required such as in tall ceiling applications. The trim and LED engine are manufactured as a single unit with endless amounts of specifications including shape and finish of trim, adjustability, color temperature, and beam distribution to create the perfect combinations of form, factor, and function.

FEATURES

- Tesla 3.5in LED Non-IC New Construction Housing
- The Tesla series is engineered with state of the art high output LED technology for optimal thermal management and heat dissipation
- Driver concealed within the fixture
- 5 year warranty

SPECIFICATIONS

Construction:	20 Gauge cold rolled steel
Power:	22.5W
Input:	120-277 VAC, 50/60Hz
Dimming:	ELV: 100-5%, 0-10V: 100-0%
Mounting:	Heavy gauge retention clips secures housing firmly to ceiling
Cut Out:	4 5/8"
Finish:	
Ceiling Thickness:	1/2" - 3/4"
Operating Temp:	-4°F to 104°F (-20°C to 40°C)
Standards:	ETL, cETL, Non IC, Airtight

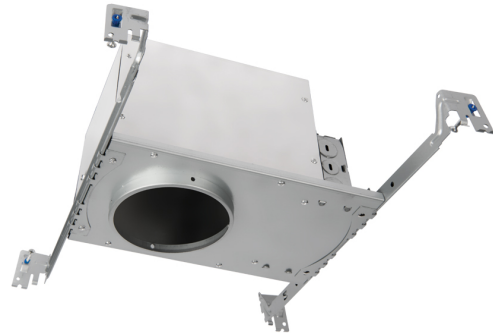

LINE DRAWING

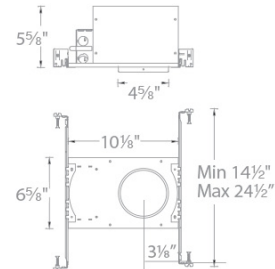

Tesla 3.5"

New Construction Housing IC Airtight

Model & Product

HR-3LED-H15D-ICA Tesla 3.5in LED IC Rated New Construction Housing

Example: **HR-3LED-H15D-ICA**

DESCRIPTION

Tesla series is at the pinnacle of where lighting innovation meets energy-efficiency. A high-performance serviceable integrated LED with a state of the art light engine delivers incredible maintenance-free optics and performance ideal for high-end residential and commercial applications. With a wide variety of solid die-cast trims in a multitude of handsome plated or powder coated finishes, the Tesla collection is sure to enhance style and appeal in any space. Tesla PRO provides up to 60% higher lumen output over the standard Tesla collection for when more lighting is required such as in tall ceiling applications. The trim and LED engine are manufactured as a single unit with endless amounts of specifications including shape and finish of trim, adjustability, color temperature, and beam distribution to create the perfect combinations of form, factor, and function.

FEATURES

- Tesla 3.5in LED IC Rated New Construction Housing
- The Tesla series is engineered with state of the art high output LED technology for optimal thermal management and heat dissipation
- Driver concealed within the fixture
- 5 year warranty

SPECIFICATIONS

Construction:	20 Gauge cold rolled steel
Power:	14.5W
Input:	120-277 VAC, 50/60Hz
Dimming:	ELV: 100-5%, 0-10V: 100-0%
Mounting:	Heavy gauge retention clips support trim firmly
Cut Out:	4 5/8"
Finish:	
Ceiling Thickness:	1/2" - 3/4"
Operating Temp:	-4°F to 104°F (-20°C to 40°C)
Standards:	ETL, cETL, IC, Airtight

Fixture Type: _____

Catalog Number: _____

Project: _____

Location: _____

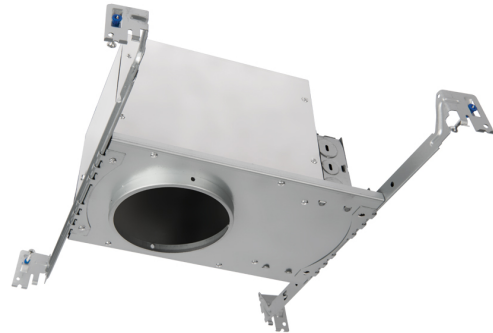

LINE DRAWING

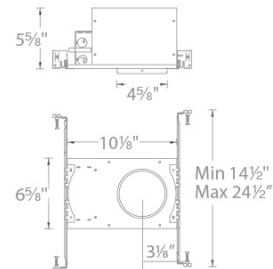

Fixture Type: _____

Catalog Number: _____

Project: _____

Location: _____

Tesla 3.5"

New Construction Housing IC Airtight

Model & Product

HR3LED-H18D1 Tesla 3.5in LED IC-Rated Airtight Narrow New Construction Housing

Example: **HR-3LED-H18D1-ICA**

DESCRIPTION

Tesla series is at the pinnacle of where lighting innovation meets energy-efficiency. A high-performance serviceable integrated LED with a state of the art light engine delivers incredible maintenance-free optics and performance ideal for high-end residential and commercial applications. With a wide variety of solid die-cast trims in a multitude of handsome plated or powder coated finishes, the Tesla collection is sure to enhance style and appeal in any space. Tesla PRO provides up to 60% higher lumen output over the standard Tesla collection for when more lighting is required such as in tall ceiling applications. The trim and LED engine are manufactured as a single unit with endless amounts of specifications including shape and finish of trim, adjustability, color temperature, and beam distribution to create the perfect combinations of form, factor, and function.

FEATURES

- Tesla 3.5in LED IC-Rated Airtight Narrow New Construction Housing
- The Tesla series is engineered with state of the art high output LED technology for optimal thermal management and heat dissipation
- Driver concealed within the fixture
- 5 year warranty

SPECIFICATIONS

Construction:	20 Gauge cold rolled steel
Power:	21.5W
Input:	120-277 VAC, 50/60Hz
Dimming:	ELV: 100-5%, 0-10V: 100-0%
Mounting:	Heavy gauge retention clips secures housing firmly to ceiling
Cut Out:	4 5/8"
Finish:	
Ceiling Thickness:	1/2" - 3/4"
Operating Temp:	-4°F to 104°F (-20°C to 40°C)
Standards:	ETL, cETL, IC, Airtight



LINE DRAWING

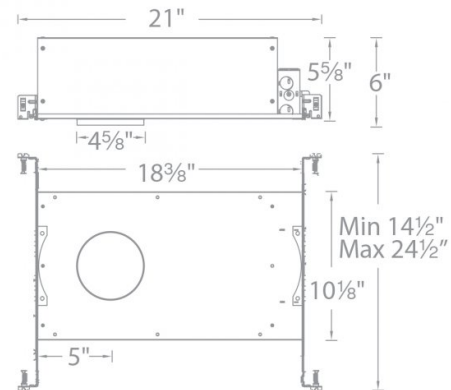

Fixture Type: _____

Catalog Number: _____

Project: _____

Location: _____

Tesla 3.5" Remodel Housing

Model & Product

HR-3LED-R22D Tesla 3.5in LED Non-IC Remodel Housing for Adjustable Trim

Example: **HR-3LED-R22D**

DESCRIPTION

Tesla series is at the pinnacle of where lighting innovation meets energy-efficiency. A high-performance serviceable integrated LED with a state of the art light engine delivers incredible maintenance-free optics and performance ideal for high-end residential and commercial applications. With a wide variety of solid die-cast trims in a multitude of handsome plated or powder coated finishes, the Tesla collection is sure to enhance style and appeal in any space. Tesla PRO provides up to 60% higher lumen output over the standard Tesla collection for when more lighting is required such as in tall ceiling applications. The trim and LED engine are manufactured as a single unit with endless amounts of specifications including shape and finish of trim, adjustability, color temperature, and beam distribution to create the perfect combinations of form, factor, and function.

FEATURES

- Tesla 3.5in LED Non-IC Remodel Housing for Adjustable Trim
- The Tesla series is engineered with state of the art high output LED technology for optimal thermal management and heat dissipation
- Driver concealed within the fixture
- 5 year warranty

SPECIFICATIONS

Construction:	20 Gauge cold rolled steel
Power:	21.5W
Input:	120-277 VAC, 50/60Hz
Dimming:	ELV: 100-5%, 0-10V: 100-0%
Mounting:	Heavy gauge retention clips secures housing firmly to ceiling
Cut Out:	4 5/8"
Finish:	
Ceiling Thickness:	1/2" - 1"
Operating Temp:	-4°F to 104°F (-20°C to 40°C)
Standards:	ETL, cETL, Non IC

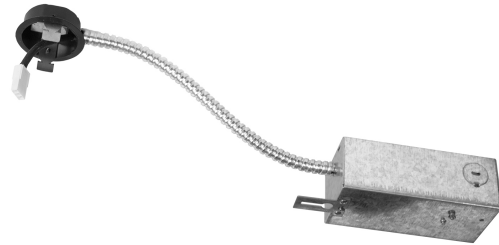

LINE DRAWING

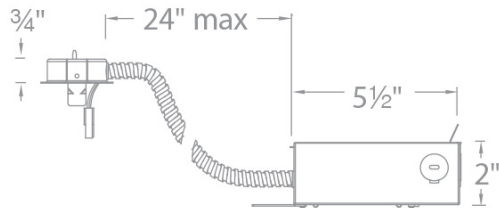

WAC LIGHTING

Fixture Type: _____

Catalog Number: _____

Project: _____

Location: _____

Tesla 3.5"

Remodel Housing Airtight

Model & Product

HR-3LED-R18D-A Tesla 3.5in LED Non-IC Remodel Housing

Example: **HR-3LED-R18D-A**

DESCRIPTION

Tesla series is at the pinnacle of where lighting innovation meets energy-efficiency. A high-performance serviceable integrated LED with a state of the art light engine delivers incredible maintenance-free optics and performance ideal for high-end residential and commercial applications. With a wide variety of solid die-cast trims in a multitude of handsome plated or powder coated finishes, the Tesla collection is sure to enhance style and appeal in any space. Tesla PRO provides up to 60% higher lumen output over the standard Tesla collection for when more lighting is required such as in tall ceiling applications. The trim and LED engine are manufactured as a single unit with endless amounts of specifications including shape and finish of trim, adjustability, color temperature, and beam distribution to create the perfect combinations of form, factor, and function.

FEATURES

- Tesla 3.5in LED Non-IC Remodel Housing
- The Tesla series is engineered with state of the art high output LED technology for optimal thermal management and heat dissipation
- Driver concealed within the fixture
- 5 year warranty

SPECIFICATIONS

Construction:	20 Gauge cold rolled steel
Power:	21.5W
Input:	120-277 VAC, 50/60Hz
Dimming:	ELV: 100-5%, 0-10V: 100-0%
Mounting:	Heavy gauge retention clips secures housing firmly to ceiling
Cut Out:	4 5/8"
Finish:	
Ceiling Thickness:	1/2" - 3/4"
Operating Temp:	-4°F to 104°F (-20°C to 40°C)
Standards:	ETL, cETL, Non IC, Airtight



LINE DRAWING

