

Fixture Type: _____

Catalog Number: _____

Project: _____

Location: _____

Tesla Pro 3.5" Shower Trim Square

| Model | Beam | Color Temp & CRI | Lumens | CBCP | Finish |
|-------------|-------|------------------|--------|------|-------------------|
| HR3LEDT818P | N 30° | 827 2700K - 80 | 1120 | 2281 | BN Brushed Nickel |
| | | 830 3000K - 80 | 1165 | 2351 | CB Copper Bronze |
| | | 835 3500K - 80 | 1270 | 2563 | WT White |
| | | 840 4000K - 80 | 1295 | 2603 | |
| | | 927 2700K - 90 | 950 | 1936 | |
| | | 930 3000K - 90 | 1065 | 2183 | |

Example: **HR3LEDT818PN827BN**

DESCRIPTION

Tesla series is at the pinnacle of where lighting innovation meets energy-efficiency. A high-performance serviceable integrated LED with a state of the art light engine delivers incredible maintenance-free optics and performance ideal for high-end residential and commercial applications. With a wide variety of solid die-cast trims in a multitude of handsome plated or powder coated finishes, the Tesla collection is sure to enhance style and appeal in any space. Tesla PRO provides up to 60% higher lumen output over the standard Tesla collection for when more lighting is required such as in tall ceiling applications. The trim and LED engine are manufactured as a single unit with endless amounts of specifications including shape and finish of trim, adjustability, color temperature, and beam distribution to create the perfect combinations of form, factor, and function.

FEATURES

- 30° visual cutoff angle for glare control
- 5 year warranty

SPECIFICATIONS

| | |
|---------------------------|--|
| Construction: | Die-cast aluminum construction |
| Power: | 22W |
| Input: | 120-277 VAC, 50/60Hz |
| Dimming: | ELV: 100-5%, 0-10V: 100-0% |
| Light Source: | Integrated LED |
| | 3 Step Mac Adam Ellipse |
| Rated Life: | 50000 Hours |
| Mounting: | Heavy gauge retention clips support trim firmly |
| Finish: | Electrostatically Powder Coated White, Electroplated Copper Bronze, Electroplated Brushed Nickel |
| Ceiling Thickness: | 1/2" - 3/4" |
| Operating Temp: | -4°F to 104°F (-20°C to 40°C) |
| Standards: | ETL, cETL, Wet Location Listed |



FINISHES

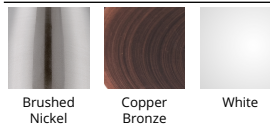

LINE DRAWING

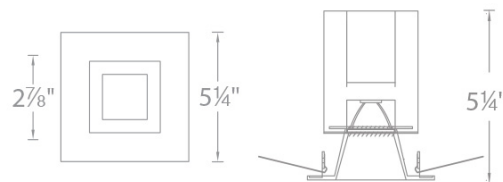

Fixture Type: _____

Catalog Number: _____

Project: _____

Location: _____

Tesla 3.5"

New Construction Housing Airtight

Model & Product

HR-3LED-H22D-A Tesla 3.5in LED Non-IC New Construction Housing

Example: **HR-3LED-H22D-A**

DESCRIPTION

Tesla series is at the pinnacle of where lighting innovation meets energy-efficiency. A high-performance serviceable integrated LED with a state of the art light engine delivers incredible maintenance-free optics and performance ideal for high-end residential and commercial applications. With a wide variety of solid die-cast trims in a multitude of handsome plated or powder coated finishes, the Tesla collection is sure to enhance style and appeal in any space. Tesla PRO provides up to 60% higher lumen output over the standard Tesla collection for when more lighting is required such as in tall ceiling applications. The trim and LED engine are manufactured as a single unit with endless amounts of specifications including shape and finish of trim, adjustability, color temperature, and beam distribution to create the perfect combinations of form, factor, and function.

FEATURES

- Tesla 3.5in LED Non-IC New Construction Housing
- The Tesla series is engineered with state of the art high output LED technology for optimal thermal management and heat dissipation
- Driver concealed within the fixture
- 5 year warranty

SPECIFICATIONS

| | |
|---------------------------|---|
| Construction: | 20 Gauge cold rolled steel |
| Power: | 22.5W |
| Input: | 120-277 VAC, 50/60Hz |
| Dimming: | ELV: 100-5%, 0-10V: 100-0% |
| Mounting: | Heavy gauge retention clips secures housing firmly to ceiling |
| Cut Out: | 4 5/8" |
| Finish: | |
| Ceiling Thickness: | 1/2" - 3/4" |
| Operating Temp: | -4°F to 104°F (-20°C to 40°C) |
| Standards: | ETL, cETL, Non IC, Airtight |



LINE DRAWING

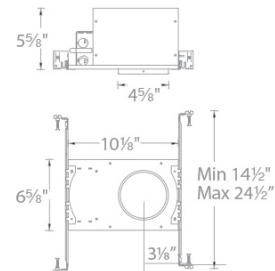

Tesla 3.5"

New Construction Housing IC Airtight

Model & Product

HR-3LED-H15D-ICA Tesla 3.5in LED IC Rated New Construction Housing

Example: **HR-3LED-H15D-ICA**

DESCRIPTION

Tesla series is at the pinnacle of where lighting innovation meets energy-efficiency. A high-performance serviceable integrated LED with a state of the art light engine delivers incredible maintenance-free optics and performance ideal for high-end residential and commercial applications. With a wide variety of solid die-cast trims in a multitude of handsome plated or powder coated finishes, the Tesla collection is sure to enhance style and appeal in any space. Tesla PRO provides up to 60% higher lumen output over the standard Tesla collection for when more lighting is required such as in tall ceiling applications. The trim and LED engine are manufactured as a single unit with endless amounts of specifications including shape and finish of trim, adjustability, color temperature, and beam distribution to create the perfect combinations of form, factor, and function.

FEATURES

- Tesla 3.5in LED IC Rated New Construction Housing
- The Tesla series is engineered with state of the art high output LED technology for optimal thermal management and heat dissipation
- Driver concealed within the fixture
- 5 year warranty

SPECIFICATIONS

| | |
|---------------------------|---|
| Construction: | 20 Gauge cold rolled steel |
| Power: | 14.5W |
| Input: | 120-277 VAC, 50/60Hz |
| Dimming: | ELV: 100-5%, 0-10V: 100-0% |
| Mounting: | Heavy gauge retention clips support trim firmly |
| Cut Out: | 4 5/8" |
| Finish: | |
| Ceiling Thickness: | 1/2" - 3/4" |
| Operating Temp: | -4°F to 104°F (-20°C to 40°C) |
| Standards: | ETL, cETL, IC, Airtight |

Fixture Type: _____

Catalog Number: _____

Project: _____

Location: _____

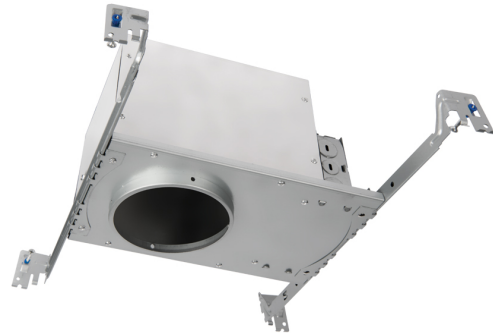

LINE DRAWING

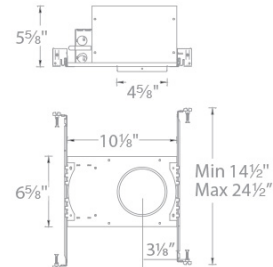

Fixture Type: _____

Catalog Number: _____

Project: _____

Location: _____

Tesla 3.5"

New Construction Housing IC Airtight

Model & Product

HR3LED-H18D1 Tesla 3.5in LED IC-Rated Airtight Narrow New Construction Housing

Example: **HR-3LED-H18D1-ICA**

DESCRIPTION

Tesla series is at the pinnacle of where lighting innovation meets energy-efficiency. A high-performance serviceable integrated LED with a state of the art light engine delivers incredible maintenance-free optics and performance ideal for high-end residential and commercial applications. With a wide variety of solid die-cast trims in a multitude of handsome plated or powder coated finishes, the Tesla collection is sure to enhance style and appeal in any space. Tesla PRO provides up to 60% higher lumen output over the standard Tesla collection for when more lighting is required such as in tall ceiling applications. The trim and LED engine are manufactured as a single unit with endless amounts of specifications including shape and finish of trim, adjustability, color temperature, and beam distribution to create the perfect combinations of form, factor, and function.

FEATURES

- Tesla 3.5in LED IC-Rated Airtight Narrow New Construction Housing
- The Tesla series is engineered with state of the art high output LED technology for optimal thermal management and heat dissipation
- Driver concealed within the fixture
- 5 year warranty

SPECIFICATIONS

| | |
|---------------------------|---|
| Construction: | 20 Gauge cold rolled steel |
| Power: | 21.5W |
| Input: | 120-277 VAC, 50/60Hz |
| Dimming: | ELV: 100-5%, 0-10V: 100-0% |
| Mounting: | Heavy gauge retention clips secures housing firmly to ceiling |
| Cut Out: | 4 5/8" |
| Finish: | |
| Ceiling Thickness: | 1/2" - 3/4" |
| Operating Temp: | -4°F to 104°F (-20°C to 40°C) |
| Standards: | ETL, cETL, IC, Airtight |



LINE DRAWING

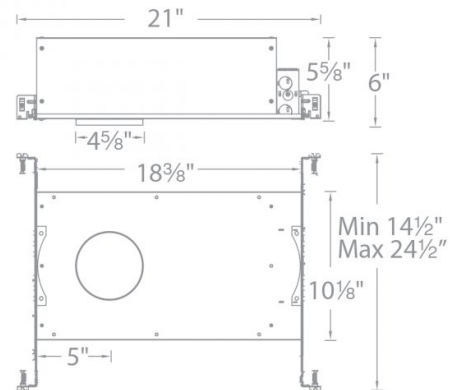

Fixture Type: _____

Catalog Number: _____

Project: _____

Location: _____

Tesla 3.5" Remodel Housing

Model & Product

HR-3LED-R22D Tesla 3.5in LED Non-IC Remodel Housing for Adjustable Trim

Example: **HR-3LED-R22D**

DESCRIPTION

Tesla series is at the pinnacle of where lighting innovation meets energy-efficiency. A high-performance serviceable integrated LED with a state of the art light engine delivers incredible maintenance-free optics and performance ideal for high-end residential and commercial applications. With a wide variety of solid die-cast trims in a multitude of handsome plated or powder coated finishes, the Tesla collection is sure to enhance style and appeal in any space. Tesla PRO provides up to 60% higher lumen output over the standard Tesla collection for when more lighting is required such as in tall ceiling applications. The trim and LED engine are manufactured as a single unit with endless amounts of specifications including shape and finish of trim, adjustability, color temperature, and beam distribution to create the perfect combinations of form, factor, and function.

FEATURES

- Tesla 3.5in LED Non-IC Remodel Housing for Adjustable Trim
- The Tesla series is engineered with state of the art high output LED technology for optimal thermal management and heat dissipation
- Driver concealed within the fixture
- 5 year warranty

SPECIFICATIONS

| | |
|---------------------------|---|
| Construction: | 20 Gauge cold rolled steel |
| Power: | 21.5W |
| Input: | 120-277 VAC, 50/60Hz |
| Dimming: | ELV: 100-5%, 0-10V: 100-0% |
| Mounting: | Heavy gauge retention clips secures housing firmly to ceiling |
| Cut Out: | 4 5/8" |
| Finish: | |
| Ceiling Thickness: | 1/2" - 1" |
| Operating Temp: | -4°F to 104°F (-20°C to 40°C) |
| Standards: | ETL, cETL, Non IC |

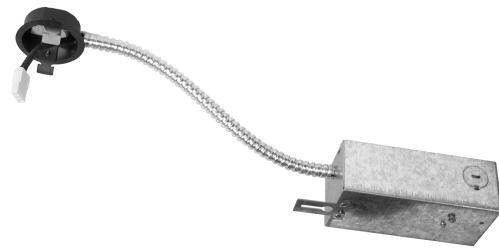

LINE DRAWING

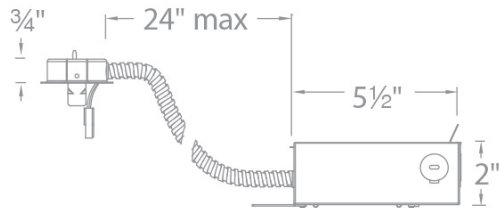

WAC LIGHTING

Tesla 3.5" Remodel Housing Airtight

Model & Product

HR-3LED-R18D-A Tesla 3.5in LED Non-IC Remodel Housing

Example: **HR-3LED-R18D-A**

DESCRIPTION

Tesla series is at the pinnacle of where lighting innovation meets energy-efficiency. A high-performance serviceable integrated LED with a state of the art light engine delivers incredible maintenance-free optics and performance ideal for high-end residential and commercial applications. With a wide variety of solid die-cast trims in a multitude of handsome plated or powder coated finishes, the Tesla collection is sure to enhance style and appeal in any space. Tesla PRO provides up to 60% higher lumen output over the standard Tesla collection for when more lighting is required such as in tall ceiling applications. The trim and LED engine are manufactured as a single unit with endless amounts of specifications including shape and finish of trim, adjustability, color temperature, and beam distribution to create the perfect combinations of form, factor, and function.

FEATURES

- Tesla 3.5in LED Non-IC Remodel Housing
- The Tesla series is engineered with state of the art high output LED technology for optimal thermal management and heat dissipation
- Driver concealed within the fixture
- 5 year warranty

SPECIFICATIONS

| | |
|--------------------|---|
| Construction: | 20 Gauge cold rolled steel |
| Power: | 21.5W |
| Input: | 120-277 VAC, 50/60Hz |
| Dimming: | ELV: 100-5%, 0-10V: 100-0% |
| Mounting: | Heavy gauge retention clips secures housing firmly to ceiling |
| Cut Out: | 4 5/8" |
| Finish: | |
| Ceiling Thickness: | 1/2" - 3/4" |
| Operating Temp: | -4°F to 104°F (-20°C to 40°C) |
| Standards: | ETL, cETL, Non IC, Airtight |



LINE DRAWING

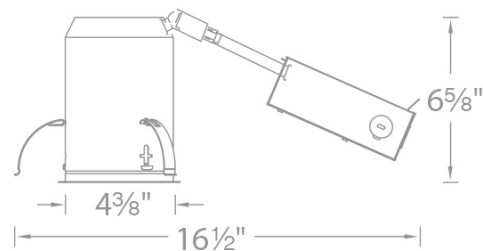

Fixture Type: _____

Catalog Number: _____

Project: _____

Location: _____